



**USER MANUAL**

---

# SI-AQ EXPERT

## **MULTIFUNCTIONAL PORTABLE INDOOR AIR QUALITY MONITOR**

## TABLE OF CONTENTS

CHAPTER 1 - TECHNICAL SPECIFICATIONS & SAFETY GUIDELINES .....	3
CHAPTER 2 - INTRODUCTION.....	8
CHAPTER 3 - BASIC INSTRUMENT OPERATION .....	12
CHAPTER 4 - POWER REQUIREMENTS .....	14
CHAPTER 5 - SENSORS - TECHNICAL .....	15
CHAPTER 6 - SI-AQ EXPERT SETUP .....	20
CHAPTER 7 - INTERNAL DATA STORAGE .....	22
CHAPTER 8 - WIRELESS REMOTE PRINTER.....	24
CHAPTER 9 - CALIBRATION.....	26
CHAPTER 10 - SI-AQ PCSOFT SOFTWARE.....	29
CHAPTER 11 - MAINTENANCE .....	33
CHAPTER 12 - SI-AQ EXPERT OPTIONS .....	34
CHAPTER 13 - BASIC TROUBLESHOOTING .....	36
CHAPTER 14 - REPLACEMENT PARTS.....	37
CHAPTER 15 - VOCs Ionization Potentials and Response Factors .....	38

## TECHNICAL SPECIFICATIONS & SAFETY GUIDELINES

### SI-AQ EXPERT - AIR QUALITY MONITOR

#### 1. PHYSICAL

Material: White ABS plastic case with internal aluminum shielding  
Dimensions (monitor): 11.42" X 10.24" X 4.88" / 27.9 x 25.4 x 10.2 cm (H x L x P)  
Weight: (monitor): 15 lbs. / 7 kg  
Shipping Dimensions & Weight (monitor & all accessories): 15 lbs. / 7 kg  
19" x 17" x 15" / 48.2 cm x 43.1 cm x 38.1 cm

#### 2. POWER

12 Volt, 8 AH rechargeable Li-Ion battery pack  
Operating time: 6 – 8 hours continuous use  
110/240 VAC input, 12 V/2.5A fast charger  
Charging time: 3 hours maximum

#### 3. DISPLAY

2.6" x 1.4" 128 x 64 graphic, chip on glass (white backlit) LCD display.  
Small and large fonts, plus inverted background colour for help messages  
Battery condition & charger operation indicator

#### 4. WIRELESS REMOTE PRINTER

High resolution, high speed, graphic thermal printer, with charger, prints:  
A. current set of data  
B. stored data  
C. periodic data printouts  
D. calibration history and external messages

#### 5. INSTRUMENT PUMP

Continuous Air sample pump: high quality diaphragm pump with long life motor.  
Pump flow: 500 cc/min

#### 6. MEMORY STORAGE

2000 Internal memory storage tags. A tag corresponds to a memory position  
Each tag stores one complete set of data including all parameters measured and calculated

#### 7. COMMUNICATIONS

Bluetooth® wireless: Class 1 (100 m)  
USB Cable

#### 8. SOFTWARE

SI-AQ GAS Windows PC Software

#### 9. GENERAL FEATURES

Recommended operating temperature: 23 to 113°F (-5 to +45 °C)  
Recommended operating relative humidity: 15 to 85% RH  
Recommended storage temperature: 14 to 122°F (-10 to +50°C)  
Standards & directives: 2014/30/EU; 2014/35/EU Low voltage; 2014/53/EU; 2011/65/EU; 2012/19/EU  
Supply voltage: 110-240 VAC  
Frequency range: 50-60 Hz  
Power rating: 25 W  
Ingress protection (IP) rating: IP40  
Reading may be affected if the unit is operated within the immediate proximity of electromagnetic frequency field of approximately 3 volts per meter. But the performance of the instrument will not be permanently affected.

## SENSORS

### 1. AIR QUALITY SENSORS – ELECTROCHEMICAL

SENSOR		RANGE	RESOLUTION	ACCURACY*
CARBON MONOXIDE (CO)	<b>Std Range</b>	0 - 200 ppm	0.1 ppm	±4% rdg ±0.5 ppm
OXYGEN (O <sub>2</sub> )	<b>Std Range</b>	0 - 25%	0.1%	0.1% Vol. rdg
NITRIC OXIDE (NO)	<b>Std. Range</b>	0 - 250 ppm	0.1 ppm	±4% rdg ±0.5 ppm
NITROGEN DIOXIDE (NO <sub>2</sub> )	<b>Std. Range</b>	0 - 20 ppm	0.1 ppm	±4% rdg ±0.5 ppm
SULFUR DIOXIDE (SO <sub>2</sub> )	<b>Std. Range</b>	0 - 20 ppm	0.1 ppm	±4% rdg ±0.5 ppm
HYDROGEN SULPHIDE (H <sub>2</sub> S)	<b>Std. Range</b>	0 - 100 ppm	1 ppm	±4% rdg ±0.5 ppm
OZONE (O <sub>3</sub> )	<b>Std. Range</b>	0 - 5 ppm	1 ppb	
FORMALDEHYDE (CH <sub>2</sub> O)**	<b>Std. Range</b>	0 – 10,000 ppb	1 ppb	5% rdg ±50 ppb

### 2. AIR QUALITY SENSORS – NON-DISPERSIVE INFRARED (NDIR) SENSORS

SENSOR		RANGE	RESOLUTION	ACCURACY*
CARBON DIOXIDE (CO <sub>2</sub> )	<b>Std Range</b>	0 – 5,000 ppm	1 ppm	2% rdg ±10 ppm
CARBON DIOXIDE (CO <sub>2</sub> )	High Range	0.0% - 20.0%	0.1%	±3% rdg

### 3. AIR QUALITY SENSORS – PHOTO IONIZATION DETECTOR (PID) SENSORS

SENSOR		RANGE	RESOLUTION	Min Detection	ACCURACY*
VOCs	<b>Std Range</b>	0 - 20,000 ppb 0 - 46,000 µg/m <sup>3</sup>	1 ppb 1 µg/m <sup>3</sup>	5 ppb	10% rdg ±20 ppb
VOCs	High Range	0 - 200 ppm 0 – 460 mg/m <sup>3</sup>	1 ppm 1 mg/m <sup>3</sup>	25 ppm	10% rdg ±2 ppm

*\*Note: All Accuracies indicated above are under Laboratory Conditions*

*\*\* This sensor may have interference from H<sub>2</sub>S, H<sub>2</sub>, CO, and other reducing gases such as alcohols*

#### 4. OTHER SENSORS

<b>SENSOR</b>	<b>RANGE</b>	<b>RESOLUTION</b>	<b>ACCURACY*</b>
Temperature Type K (T1)	0 - 2000 °F 0 - 1100 °C	1 °F 1 °C	5 °F / 3 °C or 2% rdg
Ambient Temperature	-40 – 257 °F -40 – 125 °C	0.1 °F 0.1 °C	±0.4 °F (32 - 140 °F) ±0.4 °C (0 - 60 °C)
Barometric Pressure	260 – 1260 mbar	1 mbar	±2 mbar
Relative Humidity	5 - 95%	0.1%	±2% RH
Pressure	0 - 32.0 inH <sub>2</sub> O 0 - 80 mbar	0.1 inH <sub>2</sub> O 0.1 mbar	±1% rdg
Air Velocity	0 - 300 ft/s 0 - 91 m/s	1 ft/s 1 m/s	

*\*Note: All Accuracies indicated above are under Laboratory Conditions*

## MODEL SI-AQ EXPERT – SAFETY GUIDELINES

This section provides general rules which must be followed for product safety, avoiding personal injury, damage to equipment and preserving the manufacturer's warranty. Please take care to carefully observe the following instructions.

### A. PRODUCT SAFETY INSTRUCTIONS:

**NOTE: Please take special care when performing Span Calibration of the monitor. You cannot revert back to the factory setting after any adjustments!**

**NOTE: CO<sub>2</sub> should ALWAYS be Calibrated or Zeroed with a Cylinder of ZERO AIR. Do Not Use Si-AQ VOC Zero Filter for CO<sub>2</sub> sensor calibration.**

- Follow the instructions in the Si-AQ Expert Manual
- Do not operate the instrument outside of the parameters specified in the technical specifications
- Never use the instrument without the disposable fiber soot line filter or the condensation disk filter, which are located inside the monitor connected to the "Sample In" input. Operating the instrument without the filters will put the monitor at high risk to damage the pump and sensors. These filters should be replaced as needed. See maintenance chapter for filter changing.
- It is recommended to keep the Si-AQ Expert horizontal using the included swivel handle as its stand with the LCD display facing the user
- Do not use or store the instrument together with any solvents
- Do not block the exhaust port in the back of the instrument
- Do not expose the monitor to extreme hot or cold temperatures outside of the stated range in this manual
- Do not abuse the charger cord. Do not use power cord for carrying, pulling. Keep cord away from heat, oil, sharp edges, or moving parts. Damaged or entangled cords can increase risk of electric shock
- Only use the supplied, appropriate AC Charger
- If the monitor enclosure is ever unscrewed and taken apart, avoid over-tightening the screws that hold the two main enclosure pieces together.
- Do not store or operate in dusty, dirty areas
- Always use the monitor with care and use the instrument properly
- Do not use force when disconnecting and reconnecting the Black external Temp, RH and Pressure Sensor (see photo below)
- Do not use instrument in the rain or high moisture areas to prevent water droplets on the black external Temp, RH, and Pressure Sensor.
- Remember to have the monitor checked and calibrated at least once a year to ensure sensor accuracy and compliance with existing standards
- Only accessories which meet the manufacturer's specifications shall be used.
- This device has been developed, produced and sold exclusively to trained and qualified experts in the field of air quality monitoring. Appropriate training is necessary in order to guarantee a riskless use of this instrument. Sauermann is not responsible for any possible accidents during its use.
- The device must not be used in ATEX zones according to applicable standards.
- Do not use the device next to explosive gases, vapors, or dust.
- Clean the product with a dry and clean cloth after each use.
- To avoid any risk due to voltage on the surface of the probe, it is important that the thermocouple is not subjected to a voltage.
- The power to the instrument is turned off by disconnecting the external power supply.

- Do not use the device if it is damaged or if it operates abnormally. Inspect the device before every use. In case of doubt, please contact Sauermann's after-sales service.
- **DO NOT LIFT OR HANDLE THE INSTRUMENT BY THE BLACK EXTERNAL TEMP, RH, PRESSURE SENSOR HOUSING! See photo below**



#### B. ELECTROMAGNETIC COMPATIBILITY

Complies with EN61326-1, Portable Equipment

The Sauermann SI-AQ EXPERT Indoor Air Quality Monitor is a battery-operated Portable device designed to be used by a qualified engineer/technician to make measurements in buildings and residential facilities. For long-term testing, you may operate the unit connected to the supplied charger by carefully following the product safety instructions in Section A above.

#### C. ESD PROTECTION

In extreme cases or abnormal applications, Electrostatic Discharge can potentially cause serious and immediate damage to the electronic circuits of the instrument.

#### D. BATTERY DISPOSAL & RECYCLING



Recycle all applicable material properly. Take faulty/depleted batteries to proper collection/recycling centres



Dispose of batteries and the monitor according to statutory regulations. Do not dispose of with regular household items. After the monitor's useful life, please return to your local authorized Sauermann' distributor or send back to Sauermann directly. We will ensure that it is disposed of in an environmentally friendly manner

## INTRODUCTION

### A. UNPACKING THE INSTRUMENT

Every SAUERMANN SI-AQ EXPERT includes as standard equipment:

- IAQ Monitor Model Si-AQ Expert with Temp, %RH, DPt, WBT, BP, Velocity, Differential Pressure and Differential Temperature
- Swivel Handle
- Battery charger / AC adaptor for the monitor
- USB Thumb Drive includes:
  - SI-AQ PCSOFT Software for Windows
  - Instruction Manual
- USB Cable for Software Kit
- Internal Wireless Bluetooth® module
- Calibration Certificate

The instrument can have up to six (6) electrochemical gas sensors, one (1) infrared gas sensors and one (1) PID sensor installed. The Si-AQ Expert has three temperature sensors in total. All sensor readings are single range readings with ranges listed in Chapter 1.

### B. INSTALLING/REMOVAL OF SWIVEL HANDLE INSTRUCTIONS

1. Depress BOTH of the Grey Push-Release buttons on the Left & Right circular ends of the handle (Photo B)
2. With the handle angled AWAY from the front face of the instrument and with the buttons depressed, position the circular ends OVER the Gray circular holders ON the side of the instrument until it falls into place (Photos C & D)
3. Depress the Grey Push-Release buttons and rotate the Handle down below the Front Face (Photo E) of the instrument until it locks into place under the instrument holding it upright in place. (Photo F)
4. To Remove the handle, repeat steps 1-3 in reverse



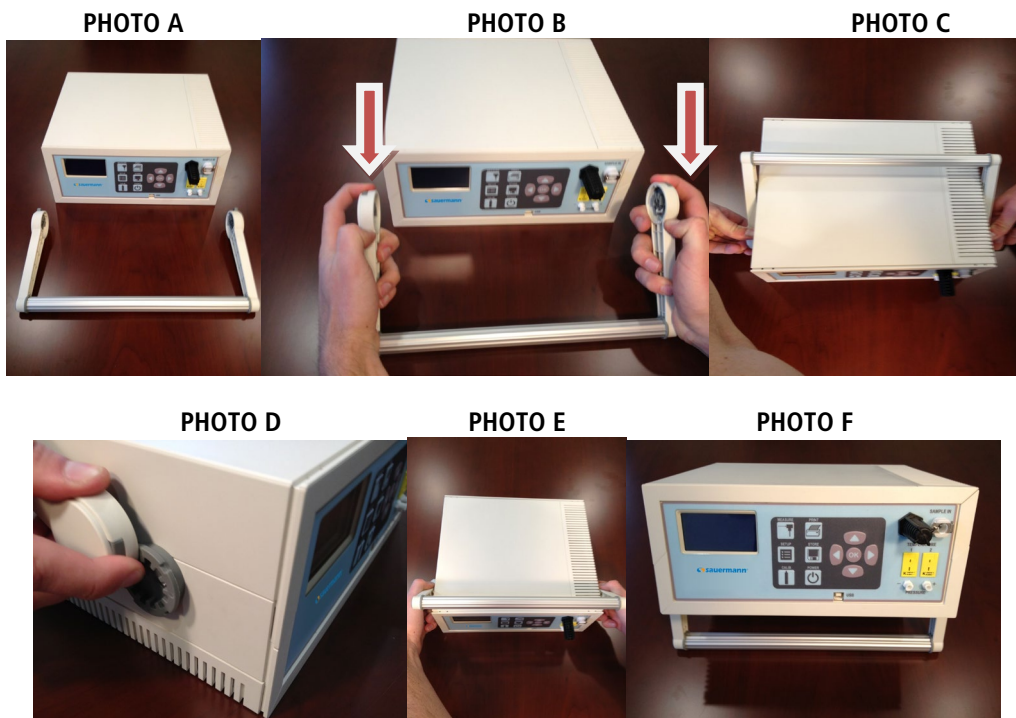

### C. REPACKING UNIT IN OPTIONAL VINYL CARRYING CASE

1. With the Si-AQ Expert powered OFF, turn the instrument on its side with the FRONT FACE of the unit to the LEFT. See photo A below.
2. Place the carrying case on a supported surface (desk, floor, etc) with the Front Logo facing the user.
3. With the Si-AQ Expert powered OFF, turn the instrument on its side with the FRONT FACE of the unit to the LEFT. See photo A below.
4. Carefully place the Si-AQ Expert in the Case, taking SPECIAL PRECAUTION to NOT damage the External Temp, RH, Pressure sensor. See Photo B below



**INSTRUCTIONS: DO NOT LIFT OR HANDLE THE INSTRUMENT BY THE BLACK EXTERNAL TEMP, RH, PRESSURE SENSOR HOUSING!**

## D. SI-AQ EXPERT STARTING INSTRUCTIONS

1. Make sure the instrument is in a clean-air, room-temperature environment and turn it on by pressing the **POWER** key on the keypad. The instrument will begin to draw in air from the SAMPLE IN inlet at a rate of about 500 cc/minute.
2. If needed or in doubt of the contaminants in the Ambient Air, you can initiate the ZERO CAL on ALL the GAS sensors on the Si-AQ Expert. Please refer to CHAPTER 8 of this manual for ZERO & SPAN calibration on the Si-AQ Expert.
3. Press the **MEASURE** key to view the ambient temperature, barometric pressure, relative humidity and dew point. According to the selected kit, the toxic gas readings are also displayed: CO, CO<sub>2</sub>, NO, NO<sub>2</sub>, SO<sub>2</sub>, H<sub>2</sub>S, O<sub>3</sub>, & VOCs.
4. If, at the end of the ZERO countdown, if the display shows an error message for a particular sensor, see the troubleshooting table in section D of this chapter. The instrument will measure correctly all sensors that do not show an error message.

## LIST OF ABBREVIATIONS

### PARAMETERS

<b>CO<sub>2</sub></b>	Carbon Dioxide
<b>CO</b>	Carbon Monoxide
<b>Ta</b>	Ambient (room) Air Temperature
<b>RH</b>	Percentage of Relative Humidity
<b>DPT</b>	Dew Point Temperature
<b>WBT</b>	Wet Bulb Temperature
<b>BP</b>	Barometric Pressure
<b>O<sub>2</sub></b>	Oxygen
<b>O<sub>3</sub></b>	Ozone
<b>VOCs</b>	Volatile Organic Compounds
<b>FMH</b>	Formaldehyde
<b>H<sub>2</sub>S</b>	Hydrogen Sulfide
<b>NO</b>	Nitric Oxide
<b>NO<sub>2</sub></b>	Nitrogen Dioxide
<b>SO<sub>2</sub></b>	Sulfur Dioxide
<b>VEL</b>	Air / Gas Velocity (measurement with pitot tube)
<b>ΔP</b>	Differential Pressure (with Velocity Probe turned OFF)
<b>T1</b>	Thermocouple Type K Temperature (T1 Input)
<b>T2</b>	Thermocouple Type K Temperature (T2 Input)
<b>BAT</b>	Battery Life / Voltage
<b>NA</b>	Parameter Not Available

### UNITS

<b>PPM</b>	Parts (of pollutant) per million
<b>PPB</b>	Parts (of pollutant) per billion
<b>mg/m<sup>3</sup></b>	Milligrams per Cubic meter
<b>μg/m<sup>3</sup></b>	Micrograms per Cubic meter
<b>°F</b>	Temperature Measurement in Fahrenheit
<b>°C</b>	Temperature Measurement in Celsius
<b>"WC</b>	Inches of water (pressure measurement)
<b>mmHg</b>	Millimeters of Mercury (pressure measurement)
<b>"Hg</b>	Inches of Mercury (pressure measurement)
<b>PSI</b>	Pounds per Square Inch (pressure measurement)
<b>mmWC</b>	Millimeters of water (pressure measurement)
<b>kPa</b>	KiloPascals (pressure measurement)
<b>mbar</b>	Millibars (pressure measurement)
<b>FPS</b>	Feet per second (gas / air velocity measurement)
<b>MPS</b>	Meters per second (gas / air velocity measurement)
<b>CFM</b>	Cubic feet per minute (gas / air velocity measurement)
<b>V</b>	Voltage (battery)

*NOTE: MGM (milligrams per cubic meter) units are calculated and displayed for 20C and 1 atm conditions per US EPA standards.*

## BASIC INSTRUMENT OPERATION

The SI-AQ EXPERT is operated by the 11 (eleven) buttons on the keyboard located on the front of the monitor.

- The **POWER** key turns the instrument on and off.
- The **MEASURE** key shows the currently measured parameters.

Displays the monitor's currently measured data in either of two (2) fonts:

- A. Small fonts (all data displayed simultaneously plus range indicated, battery condition and time)
- B. Large fonts (four data parameters displayed simultaneously)

**Note:** The Si-AQ Expert allows the user to ZOOM in and out of the screen by changing from Small to Large Fonts using the **MEASURE** key.

- Four keys will bring up a menu: **SETUP, CALIB, STORE, & PRINT**.

**SETUP** Controls all customization parameters, such as measurement units, for the monitor

**CALIB** Controls calibration settings and zeroing of the monitor's sensors.

**STORE** Controls operation of the monitor's internal data storage

**PRINT** Executes print commands for the monitor's optional remote Bluetooth® printer

- The menus are navigated with the **UP, DOWN, LEFT, RIGHT, & OK** keys.



## INSTRUMENT OPERATION OVERVIEW

1. Turn the Si-AQ Expert on by pressing the **POWER** key. The instrument's internal pump will immediately turn on and the SAUERMAN logo will appear.
2. If applicable, attach the optional probe and sampling line to the monitor.
3. Press the **MEASURE** key and check the unit's battery condition.

CO <sub>2</sub> : 520 <sub>PPM</sub>	O <sub>2</sub> : 20.9%
CO: 0 <sub>PPM</sub>	NO <sub>2</sub> : 0 <sub>PPM</sub>
Ta: 79.1°F	SO <sub>2</sub> : 0 <sub>PPM</sub>
RH: 46.9%	H <sub>2</sub> S: 0 <sub>PPM</sub>
D <sub>Pt</sub> : 57.0°F	O <sub>3</sub> : 0 <sub>PPB</sub>
BP: 1012mb	VOC: 0 <sub>PPB</sub>
Sampling  12:45:00	

*NOTE: Depending on the options enabled for your SI-AQ EXPERT some of the entries in one or more of the displays shown above will be blank if that option is not available.*

The **MEASURE** key allows the user to toggle between a small font and a large font screen. Select the small font screen.

The battery icon is displayed in the middle of the bottom line of the display. Its condition is marked by the shaded fraction of the icon. If the unit is powered by the battery charger a small "plug" icon will replace the battery icon.

**NOTE:** When connecting the battery charger to the monitor make sure that the "plug" icon appears on the **MEASURE** screen. This ensures a proper power connection and charging of the batteries.

- Battery Full
- Battery Empty
- Battery Charger Connected
- Fast-Charge Mode

APR 1 '14 12:45:00
Temperature Units: F
Measure Units: PPM
Pressure Units: inWC
Pumps: AUTO 1000cc/m
Velocity Probe: OFF
Velocity Units: FPS
Duct Size: 0 in2
Display Contrast: 24
Baudrate: 115 kbps
Version: 1.00Li

4. If you are using the monitor for the first time, press the **SETUP** key to set the appropriate parameters (i.e.: measurement units) for your application. See Chapter 5 for an explanation of each parameter.
5. All sensor readings shown on the screen indicate Ambient measurements. To ZERO the gas sensors, please see Maintenance Chapter 11 of this manual.
6. To obtain a printout of the data displayed, press the **PRINT** key. The cursor (reverse colour) will point to:

Print Test Record

Press the **OK** key to execute a printout on the Si-AQ Expert's optional remote printer.

7. Measured data can be stored in the monitor's internal memory. Please refer to Chapter 7 for more details about data storage.
8. When you are finished with your measurements allow the monitor to draw clean ambient air for several minutes before turning the monitor off. If you are using the optional probe, please disconnect and let the instrument run in clean ambient air before turning the instrument off.

## POWER REQUIREMENTS

The Si-AQ Expert can run off of AC power or the internal Li-Ion rechargeable battery pack. It is recommended to run the Si-AQ Expert off AC power as often as possible for maximum operating time.

Power is supplied by a Li-Ion rechargeable battery pack. The battery pack will supply power to the monitor for approximately 6-8 hours of continuous operation.

A 110 – 240 Volt AC charger having a 12 Volt DC / 2.5A output is supplied with the instrument. The battery charger will fully charge the battery pack in three hours.

You can check the condition of the batteries at any time:

1. By pressing the **MEASURE** key (small font screen), and observing the battery icon, located at the bottom of the display.



Battery Full



Battery Empty



Battery Charger Connected



Fast-Charge Mode

2. By pressing the **MEASURE** key, (large font screen), the user can scroll all the way to the end using the **DOWN** arrow key to observe the battery life shown in voltage. When the unit is operating on its internal batteries, the voltage displayed will vary from an initial 8.0 to 8.4 volts (fully charged) dropping slowly to approximately 7 volts (batteries nearly empty). When the battery voltage drops to 7.1 volts a “low battery” warning will appear on the display. Within a few minutes later the instrument will automatically turn off, to preserve the remaining battery power for the sensor bias voltages.

## SENSORS - TECHNICAL

The great versatility of the Si-AQ Expert Air Quality monitor is partly due to the large number of sensors available within a single monitor.

These sensors are primarily gas sensors and can be grouped into four categories based on their principle of operation:

1. Six (6) electrochemical gas sensors\*
2. One (1) NDIR (infrared gas sensors) – CO<sub>2</sub>
3. One (1) Photo ionization detector (PID gas sensor) - VOC
4. Non-gas sensors (Temperature, Velocity, Humidity, Pressure, and Barometric pressure) sensors

**\*NOTE:** When O<sub>3</sub> (Ozone) sensor is installed, the Si-AQ Expert can include O<sub>3</sub> + NO<sub>2</sub> **OR** O<sub>3</sub> + SO<sub>2</sub>.  
The unit can **NOT** have all three (3) sensors (O<sub>3</sub> + NO<sub>2</sub> + SO<sub>2</sub>) together simultaneously.

The main section of the monitor that houses all the electrochemical, NDIR, and PID gas sensors, battery pack, and PC board. On the face of the unit, the external sampling system or Ambient Temperature, Relative Humidity, and Barometric Pressure.

The figure below shows the location of the gas sensors on their housing:

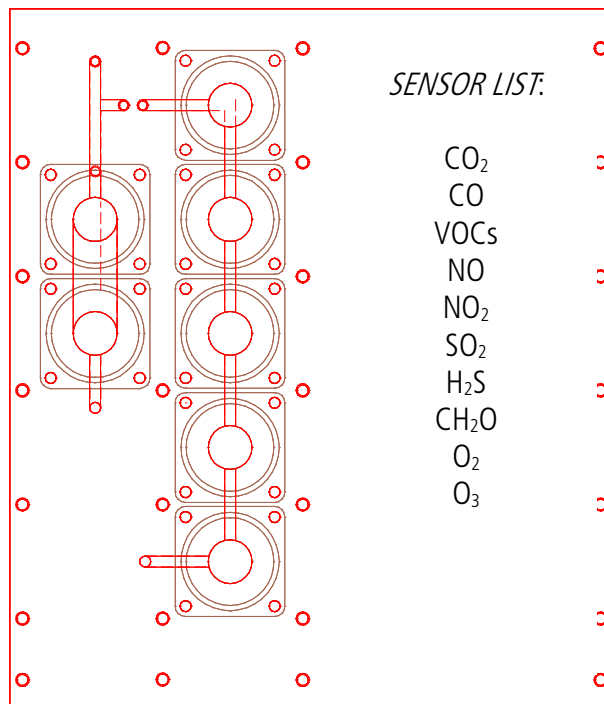

## 1. ELECTROCHEMICAL SENSORS

All electrochemical sensors are mounted on bayonet style fittings for easy removal.

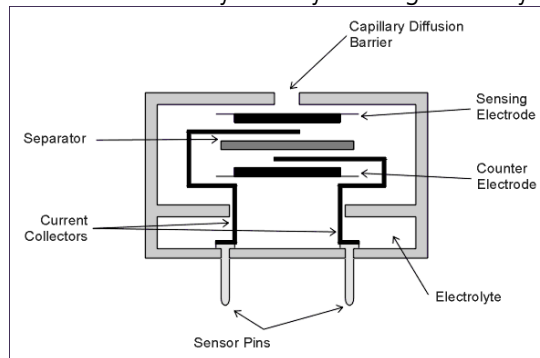

The electrochemical sensors are described below:

### A. Nitrogen Dioxide sensor ( $\text{NO}_2$ )

This is a three-electrode sensor that responds to nitrogen dioxide gas. Nitrogen dioxide is a “sticky” gas and this sensor’s response is usually the slowest of all sensors.

### B. Sulfur Dioxide sensor ( $\text{SO}_2$ )

It is a three-electrode sensor that responds to sulfur dioxide gas. It is equipped with an inboard filter to remove interference from  $\text{H}_2\text{S}$  gas and other acidic gases.

### C. Nitric Oxide sensor (NO sensor)

This is also a three-electrode sensor that responds to nitric oxide. It is equipped with an inboard filter to remove any interference from other acidic gases.

The nitric oxide sensor requires a constant bias-voltage for proper operation. This is supplied by the monitor’s battery. If the battery voltage drops below a certain value, the monitor will turn off automatically to maintain the sensor bias. If, however, the battery voltage further drops to near zero, one must wait 24 hours after connecting the battery charger, for the sensor bias to recover.

### D. Oxygen sensor ( $\text{O}_2$ sensor)

This sensor measures the oxygen concentration in the sample. It is a two-electrode electrochemical cell. It has a silver cathode and a lead anode. Oxygen diffuses through a tiny hole and reacts with the lead anode. The reaction produces an electric current. The unit software linearizes the current vs. oxygen response. The cell becomes exhausted when all the lead is consumed.

### E. Hydrogen Sulfide sensor ( $\text{H}_2\text{S}$ )

This is a 4-series three-electrode micro sensor with low methanol interference. It measures the concentration of hydrogen sulfide, which is a highly toxic gas. Special precautions must be taken during calibration.



## F. Carbon Monoxide sensor (CO)

This is also a three-electrode sensor that responds to carbon monoxide. It is equipped with an inboard filter to remove any interference from other acidic gases.

## G. Ozone sensor (O<sub>3</sub>)

This is also a three-electrode sensor that responds to ozone.

## H. Formaldehyde Sensor (CH<sub>2</sub>O)

This is also a three-electrode sensor that responds to formaldehyde. It is equipped with an inboard filter to remove any interference from other acidic gases.

This sensor may have interference from H<sub>2</sub>S, H<sub>2</sub>, CO, and other reducing gases such as alcohols. In applications where the user is measuring both H<sub>2</sub>S and Formaldehyde, the Formaldehyde readings could be inaccurate as the levels of H<sub>2</sub>S increase. Relative measurements could be appropriate in these situations.

## 2. NDIR (INFRARED) SENSOR (CO<sub>2</sub>)

A non-dispersive infrared (or NDIR) sensor is a simple spectroscopic device most commonly used to measure CO<sub>2</sub> in indoor air quality applications. The main components are an infrared source (lamp), a sample chamber or light tube, a wavelength sample chamber, and the CO<sub>2</sub> gas concentration is measured electro-optically by its absorption of a specific wavelength in the infrared (IR).

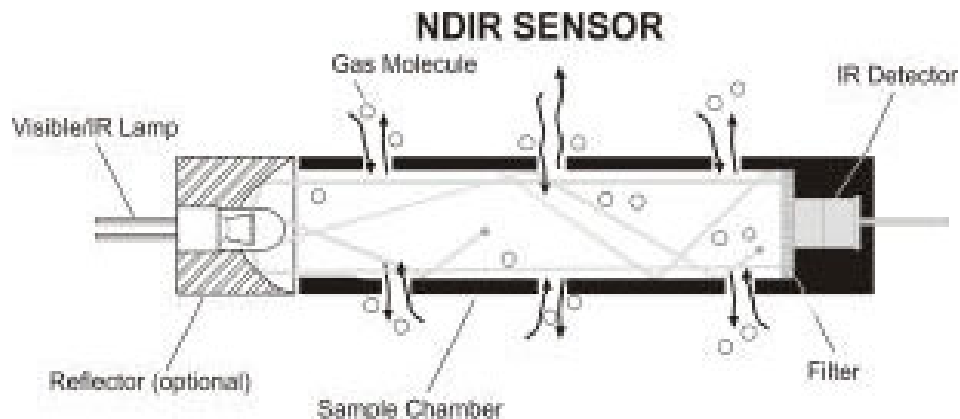

The Si-AQ Expert Air Quality Monitor is equipped with one standard NDIR infrared sensor capable of CO<sub>2</sub> measurement (standard range: 0 – 5000 ppm). This infrared sensor can be substituted for higher CO<sub>2</sub> ranges upon special request.

The NDIR options have the following specifications:

GAS	RANGE	ACCURACY
CARBON DIOXIDE (CO <sub>2</sub> )	0 - 5000 ppm	2% of reading ±10 ppm
CARBON DIOXIDE (CO <sub>2</sub> )	0.0% - 20.0%	3% of reading

### 3. PHOTO IONIZATION DETECTOR (PID) - VOCs

Photo ionization detectors are the most common method to measure volatile organic compounds (VOCs) and other gases in indoor air quality in concentrations in parts per billion (PPB) and parts per million (PPM).

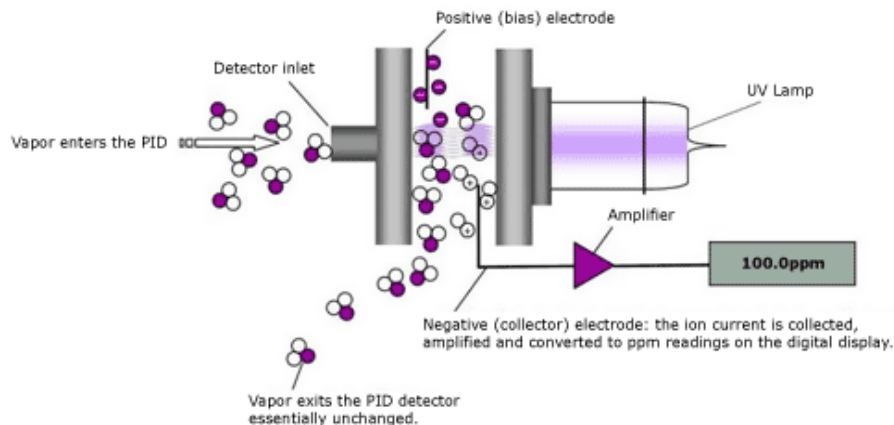

The PID options have the following specifications:

GAS	RANGE	ACCURACY
VOCs*	0 - 20,000 ppb 0 - 46,000 µg/m <sup>3</sup>	±10% rdg ±20 ppb
VOCs*	0 - 200 ppm 0 - 460 mg/m <sup>3</sup>	±10% rdg ±2 ppm

*\*VOC sensor will not measure Formaldehyde. The ionization potential of the sensor is outside of the VOC sensor range. If you need Formaldehyde, you need to use the direct CH<sub>2</sub>O sensor.*

### 4. NON-GAS SENSORS

#### A. Ambient Temperature sensor

This is a NTC sensor located on the front panel of the monitor. The ambient temperature is displayed on the **MEASURE** screen in either °F or °C. The dew point is calculated from the ambient temperature and relative humidity. The dew point is displayed on the Small and Large Font **MEASURE** screens as DPT.

B. Humidity sensor

This is a capacitive sensor located on the front panel of the monitor. The relative humidity is displayed on the **MEASURE** screen in %RH (% Relative Humidity). The Wet Bulb is calculated from the ambient temperature, relative humidity, and barometric pressure. The wet bulb is displayed on the Large Font **MEASURE** screen only as WBT.

C. Barometric Pressure sensor

This is a piezoresistive sensor located at the front panel of the monitor. The barometric pressure is displayed on the Small and Large Font **MEASURE** screens as BP.

D. External Temperature Sensor (T1 & T2)

The thermocouple is located at the tip of any optional or separate Type K thermocouple probe and/or wire. The T1 & T2 temperature measurements are displayed on the Large Font **MEASURE** screen only as T1, T2.

E. Differential Pressure / Air Velocity sensor.

If the monitor comes with the Differential Pressure option and/or the air velocity option (optional separate S-type pitot tube and pressure tubing), the internal pressure sensor is a very low range pressure sensor. The Velocity measurements are displayed on the **MEASURE** screen only as VEL. Differential Pressure are displayed on the **MEASURE** screen only as  $\Delta P$ .

### Connecting Differential Pressure Hoses:

1. Connect White Connector to either P+ or P- Connection as shown in photo below.



2. Once connected, turn White Connector CLOCKWISE to lock. Do NOT Over tighten.

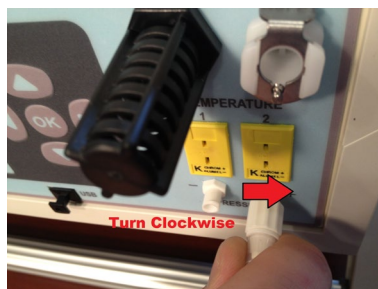

3. To Disconnect, turn White Connector COUNTER-CLOCKWISE to unlock and pull hose off to remove.

## SI-AQ EXPERT SETUP

The **SETUP** MENU allows the operator to change the instrument's parameters.

APR 1 '14 12:45:00
Temperature Units: F
Measure Units: PPM
Pressure Units: mbar
Pumps: AUTO 1000cc/m
Velocity Probe: OFF
Velocity Units: FPS
Duct Size: 0 in <sup>2</sup>
Display Contrast: 24
Baudrate: 115 kbps
Version: 1.00Li

Every parameter listed on the **SETUP** MENU screen can be changed as follows:

- Use the **UP / DOWN** keys to move the highlighted line to the parameter you wish to change.
- Press **OK** to edit the value. The arrow will disappear as the current line shifts to the left by one character and a cursor appears over the value. This indicates that you are in edit mode.
- Use the **UP / DOWN** keys (keys displaying the triangles) until the desired value of the selected parameter appears on the display.
- Press the **OK** key to execute the change.

A more detailed explanation of each parameter follows:

- DATE & TIME:** The monitor's internal clock is displayed in the format month-day-year, hour-minute-second. Hours are always displayed using a 24-hour clock format.
- TEMPERATURE UNITS:** The **UP / DOWN** keys toggle between °F (Fahrenheit) and °C (Celsius). Stack temperature and ambient temperature will be displayed, printed, and saved in the selected units.
- GAS MEASURING UNITS:** When the cursor is blinking on this line, you can select any of the following units of measurement for the toxic gas sensors:
  - PPM: Parts per million (volumetric)
  - PPB: Parts per billion (volumetric)
  - MGM: Milligrams per cubic meter (weight)
  - µGM: Micrograms per cubic meter (weight)

Note: Formaldehyde, Ozone and VOCs will always read in PPB (parts per billion)

- PRESSURE UNITS:** Pressure measurements can be shown in millibar (mbar), inches of water (inWC), millimeters of water (mmWC), millimeters of mercury (mmHG), inches of mercury (inHG), pounds per square inch (psi) or kilopascal (kPa).

$$1 \text{ mbar} = 0.10 \text{ kPa} = 0.40 \text{ inWC} = 10.2 \text{ mmWC} = 12.95 \text{ inHg} = 0.75 \text{ mmHg} = 1.45 \text{ PSI}$$

- 5) VELOCITY & AIRFLOW UNITS: (Velocity Option) Select between feet per second (FPS), meters per second (MPS), cubic feet per minute (CFM), or cubic meter per minute (CMM).

**AIR VELOCITY AND DIFFERENTIAL PRESSURE CAN NOT BE MEASURED SIMULTANEOUSLY. USER MUST CHOOSE ONE OR THE OTHER.**

To change the selection, hit the **SETUP** key. Using the **DOWN** arrow key, scroll Down to **VELOCITY PROBE** and hit **OK**. The **OFF/ON** selection will be highlighted. Use the Up & Down arrow keys to change the selection from OFF to ON or vice versa. With the Velocity Probe Selection **OFF**, the Si-AQ Expert will measure **Differential Pressure ( $\Delta P$ )** automatically. With the Velocity Probe Selection **ON**, the Si-AQ Expert will measure **Air Velocity (VEL)** automatically. When you have your selection chosen, hit the **OK** button and the entire Velocity Probe will be highlighted again. Hit the **MEASURE** Button to get back to the Main Measurement screen once you are complete.

- 6) DUCT SIZE: (Velocity Option). Estimate the cross-section area of your Ducts in square inches (in<sup>2</sup>) and set this value to obtain automatic & accurate Air Flow measurements in m/s or m<sup>3</sup>/min.

**NOTE: When using the Velocity Feature on the Si-AQ Expert it is recommended to ZERO the readings BEFORE using the Pitot tube to ensure proper Velocity measurements. See Chapter 9 for instructions on Zeroing the Si-AQ Expert. (Zero Gas Sensors)**

**Connecting Pitot Tube:** In air conditioning, heating and ventilating work, it is helpful to understand the techniques used to determine air velocity. In this field, *air velocity* (distance travelled per unit of time) is usually expressed in meters per second (m/s). By multiplying air velocity by the cross section area of a duct, you can determine the air volume flowing past a point in the duct per unit of time. *Volume flow* is usually measured in cubic meters per minute (m<sup>3</sup>/min). To make Air Velocity measurements using the Si-AQ Expert, you will need to use the *Optional 12"* Pitot tube. Follow Steps #5 & #6 above to (1) turn the Velocity Probe option ON (VEL will appear on the unit's main screen) and (2) set up your Duct Size. Connect the supplied hoses from the Pitot tube to the WHITE (-) and/or (+) PRESSURE connections on the Front of the Si-AQ Expert.

- 7) PUMP: Pump status is displayed:
  - a) AUTO - Automatic sample mode is selected
  - b) OFF – The internal Pump is turned off.
- 8) DISPLAY CONTRAST: Select the best value for viewing the LCD screen.
- 9) BAUDRATE: The communication speed for both the USB port and the Bluetooth® connection is set here. The default setting is 115 kbps.

## INTERNAL DATA STORAGE

The STORE MENU allows the operator to store data and manage the internal storage tags.

Store Current Buffer
Select Buffer
Start Average Test
Start Periodic Store
Select Interval: 1m
Review Buffer
Name Buffers
Erase Buffers
00: TAG#00

The Si-AQ Expert has 2000 internal storage tags. Each tag stores one complete set of air quality data. There are two ways to store air quality data to the monitor's buffer. You can either store data by selecting the option STORE CURRENT DATA after pressing the **STORE** key, or alternatively you can make use of the monitor's capability of storing data automatically on a periodic basis. You can set the time period between data storage. The STORAGE MENU shows the relevant display lines for the storage options.

1. STORE CURRENT BUFFER: The monitor will store one set of data into the tag currently selected. The index number and the name of this tag appear at the bottom of the screen.
2. SELECT BUFFER: Selecting this item will display an index of the monitor's 2000 internal storage tags. Tags that are used have an icon next to their index number. The selected storage tag is indicated by the reverse colour line. When data is stored, this pointer will automatically advance to the next available tag. If you want to store data in a different location, use the UP, DOWN, & OK keys to select a new tag. As you scroll up and down, tags containing data show their date and time at the bottom of the display. Empty tags show the word empty.
3. START AVERAGE TEST: This will begin a period of data averaging, with the average values stored periodically in successive memory tags. The interval between each storage cycle is displayed below and can be set by the user. Once enabled, this line will read: STOP AVERAGE TEST.
4. START PERIODIC: This will turn on the periodic store function. In this mode, the unit will continuously store data at an interval displayed on the next line. Once enabled, this line will read: STOP PERIODIC.
5. SELECT INTERVAL: The time between each store is set here. This can range from 10 seconds to 60 minutes.
6. REVIEW BUFFER: This choice allows you to view previously saved data. Press **OK**. The display will switch to the data screen, with the data in the first tag displayed. The time and date when the data was saved will appear at the bottom of the display. Use the **UP / DOWN** keys to scroll through the tags.

7. NAME BUFFERS: This choice will take you to another screen where you can rename one or more tags. This is useful if you use several tags together to form a test series. Select the starting test index with the **UP / DOWN / LEFT / RIGHT** keys and press **OK**. Next, select the ending test index. The cursor will move to the first character of the first tag's name, and the alphanumeric keyboard will appear. Use the **UP / DOWN / LEFT / RIGHT** keys to navigate around the keyboard and press **OK** to select the letter or number. For lower-case letters, highlight `shift` and press **OK**, for symbols, highlight `sym` and press **OK**. The arrows in the corner will move the cursor forward or backward through the tag's name.

*** NAME BUFFERS ***										
Starting Tag: 00										
Ending Tag: 00										
Name :xxxxxxxxxxxxxxxxxxx										
1	2	3	4	5	6	7	8	9	0	◀
A	B	C	D	E	F	G	H	sym	▶	
I	J	K	L	M	N	O	P	shift		
Q	R	S	T	U	V	W	X	Y	Z	

8. ERASE BUFFER: This option is used to erase stored data. Data that has been stored in the monitor's memory will be retained even after the instrument has been shut off and its batteries removed. To erase the contents of a specific tag, use the **UP / DOWN** keys to move the arrow to the desired tag. As you scroll up and down, tags containing data show their date and time at the bottom of the display. Empty tags show the word empty. If you wish to erase all 1000 of the monitor's stored data, move the arrow to the entry ALL TAGS and press **OK**.

## WIRELESS REMOTE PRINTER



The Si-AQ Expert uses a wireless Bluetooth® remote printer. The printer is powered by a rechargeable battery. An AC charger is supplied with the printer. The printer is optional with the Si-AQ Expert.



First you must turn the printer on. Then press **PRINT** to scan and connect with your wireless printer to establish communications between the monitor and the printer.

```
* WIRELESS PRINTERS *
Scan for printers
Press OK to search
```



```
* WIRELESS PRINTERS *
Device Found
Press OK to Connect
Device 1:001122334455
```



```
* WIRELESS PRINTERS *
Device Connected
Press OK to Continue
Device 1:001122334455
```

When you have connected successfully the printer's green status light will turn on. Pressing the **PRINT** key will now display the PRINT MENU.

The PRINT MENU allows the user to print test records.

```
Print Test Record
Start Test Log
  Log Interval: 60s
Print Buffer
Configure Record
Edit Customer Name
Calibration Record
Paper Feed On/Off
Mobile Printer...
```

```

sauermann®

Serial #: 000000
Company Name

TEST RECORD

AUG 1 '14 12:45:00

CO2: XX.X %
CO: XXXX PPM
T ambient: XXX °F
RH: XX.X %
DPt: XXX °F
WBT: XXXX °F
BP: XXXX psi
Oxygen: XX.X %
NO: XXXX PPM
NO2: XXXX PPM
NOx: XXXX PPM
SO2: XXXX PPM
H2S: XXXX PPM
O3: XXX PPM
VOC: XXX PPM
```

**PRINT TEST RECORD:** This option will print a test record of the current air quality parameters.

**PRINT TEST LOG:** This option begins a log of the following air quality parameters: CO<sub>2</sub>, Temperature, %RH, Wet Bulb, Dew Point, Barometric Pressure, Oxygen, Carbon Monoxide, VOCs, etc.

**LOG INTERVAL:** This selects the interval between each log entry. The interval can be set between 1 and 60 seconds.

**PRINT BUFFER:** This option is used to print data stored in the monitor's memory. Each line corresponds to one storage tag. Tags containing data show an icon next to the index number. When you scroll up and down, the date (mm/dd) and time (hh/mm) when the data was stored appear at the bottom; empty tags show the word "empty". To print the contents of a specific tag, use the **UP / DOWN** keys to move the arrow to the desired tag and press **OK**. If you wish to print the entire monitor's stored data in sequence, move the arrow to the entry ALL TAGS and press **OK**.



CONFIGURE RECORD: This option allows the user to add, delete, or change the order of the parameters that appear on the paper print out.

EDIT CUSTOMER NAME: This will display a screen where you can change the information printed at the top of each printout. Usually the customer's name or the operator's name appears here. To edit this information, use the **UP / DOWN / LEFT / RIGHT** keys to navigate around the keyboard, and press **OK** to select the letter or number. For lower-case letters, highlight `shift` and press **OK**, for symbols, highlight `sym` and press **OK**. The arrows in the corner will move the cursor forward or backward through the name.

** EDIT HEADER INFO **										
SAUERMANN SI-AQ EXPERT										
1	2	3	4	5	6	7	8	9	0	◀
A	B	C	D	E	F	G	H	sym	▶	
I	J	K	L	M	N	O	P	shift		
Q	R	S	T	U	V	W	X	Y	Z	

CALIBRATION RECORD: This option will print a record of each sensor's last calibration, including the date of calibration and span gas value used.

PAPER FEED: This toggles the printer's motor on and off, advancing the paper out the top of the printer as needed. The motor will not turn on if there is no paper present.

MOBILE PRINTER: The WIRELESS PRINTERS screen will appear. You can disconnect your current Bluetooth® connection and connect to another printer in range.

## CALIBRATION



**NOTE: CO<sub>2</sub> should ALWAYS be Span Calibrated or Zeroed with a Cylinder of ZERO AIR ONLY.**

Every instrument must occasionally be tested against some known value or standard in order to make sure that its accuracy has not deteriorated. If the instrument is reading outside of the stated accuracies in this manual, the unit should be calibrated.

If the unit is returned to Sauermann for Span Calibration, the unit will be shipped back after Calibration with a new Calibration Certificate valid for one (1) year. If the unit is Span Calibrated in the field, the original calibration certificate is no longer valid.

**NOTE: Please take special care when performing Calibration of the monitor. You cannot revert back to the factory setting after any adjustments!**

```

**** CALIBRATION ****
Zero Gas Sensors
Zero CO2 Sensor
Zero Thermocouples
Zero Errors
Zero Time: 60sec
Span Time: 120sec
** Span Lockout **
Sensor History
Span CO:   xxxx PPM
Span H2:   xxxx PPM
Span CO2:  xxxx PPM
Span NO:   xxxx PPM
Span NO2:  xxxx PPM
Span SO2:  xxxx PPM
Span H2S:  xxxx PPM
Span FMH:  xxxx PPB
Span Ozone: xxxx PPB
Span VOC:  xxxx PPB
Span Velocity: xx "
Span ΔP:   xx "
Span AmbT: xx.x C
Span BP:   xxxx mbar
Span RH:   xx.x %
Cal Thermcple1: xxxF
Cal Thermcple2: xxxF

```

The CALIBRATION MENU lets you set span calibration values for each sensor and performs all sensor calibrations. The CALIBRATION MENU is shown below

A brief explanation of the parameters shown follows below:

**ZERO GAS SENSORS:** This will set the zero point of CO, NO, NO<sub>2</sub>, SO<sub>2</sub>, H<sub>2</sub>S, CH<sub>2</sub>O, O<sub>2</sub>, VOCs, Pressure & Velocity values.

**ZERO CO<sub>2</sub> SENSOR:** This will set the zero point of CO<sub>2</sub>.

**ZERO THERMOCOUPLE:** This calibrates the external thermocouple input (T1) to ambient temperature.

**ZERO ERRORS:** This will display a list of sensors that were out of the monitor's acceptable range during the last zero countdown.

**ZERO TIME:** This is the countdown time for the zero procedure. The zero cycle time should set at 20-60 seconds.

**SPAN TIME:** When carrying out a span calibration, you must introduce the span gas for an appropriate amount of time before the monitor executes the span calibration. This setting, which is the same for all sensors, controls this time interval. The span time is indicated in seconds.

**SPAN LOCKOUT:** This controls access to the remaining span calibration menu options. Span lockout prevents accidental or mistaken calibrations. Span lockout is enabled and disabled by entering a 4-digit code.

**SENSOR HISTORY:** The date that each sensor was installed is displayed, along with the date the sensor was last calibrated and the span gas concentration used.

**SPAN XXXX:** The remaining lines of the CALIBRATION MENU are used for carrying out span calibrations of the CO, CO<sub>2</sub>, NO, NO<sub>2</sub>, SO<sub>2</sub>, H<sub>2</sub>S, Ozone, Formaldehyde, VOCs, and Velocity sensors. For detailed use of these settings, please refer below.

### **ZEROing VOC & Gas Sensors using Si-AQ VOC Zero Filter (with the exception of CO<sub>2</sub>) in AMBIENT AIR CONDITIONS**

**Turn the unit and let the instrument WARM UP for a minimum of 5 minutes.**

If the sensor has been stored for a significant amount of time, it may have been exposed to ambient conditions that may cause the sensor to exhibit a drifting characteristic of the baseline signal. After prolonged storage, it is recommended to power on the sensor for a period of time before operating it. The detector will clean itself and the baseline signal will drop and stabilize. If the sensor is used on a daily basis, the user should let it stabilize before use.

In order to zero the gas sensors (except CO<sub>2</sub>) in Ambient Air, insert the **Si-AQ VOC Zero Filter** into the "Sample In" inlet on the front of the Si-AQ Expert and ensure that the opening on the bottom end of the filter is not blocked. Allow the unit to run with the filter connected for at least 30 seconds before continuing, this ensures that any potential contaminants inside the unit are purged.



Press the **CALIB** key and have the cursor (reverse colour) point to Zero Gas Sensors:

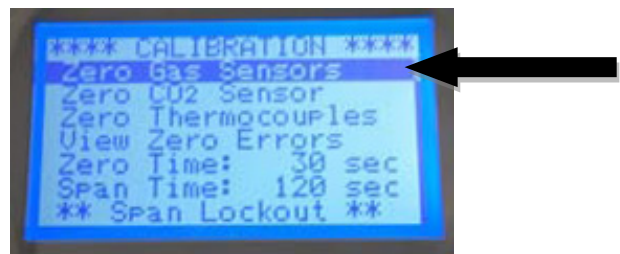

Press the **OK** key to execute a Zero cycle of all the gas sensors while the instrument is running in ambient air. This procedure should last 60 seconds.

At the end of the zero period the Si-AQ Expert reads the output of all gas sensors (except the CO<sub>2</sub> sensor) and sets them all to zero, with the exception of the Oxygen (O<sub>2</sub>) that it sets to 20.9%.

If no error messages appear at the end of the countdown, place the Si-AQ VOC Zero Filter into a sealable bag to prevent moisture from entering it.

## SI-AQ PCSOFT SOFTWARE

### 1. COMMUNICATIONS

The Si-AQ Expert Monitor communicates with a PC either using the USB cable or wirelessly using its internal Bluetooth® (BT) module. If your computer does not have internal BT capabilities, use the external BT module that is supplied with the Si-AQ Expert.

The communication protocol is as follows:

BAUD RATE: 115000 baud  
FORMAT: 8 bits, 1 stop bit, no parity  
HANDSHAKE: None

### USB CONNECTION

For USB connections, use the A-to-B type USB cable supplied with the instrument. To establish a USB connection, the FTDI USB driver must first be installed on your computer. The USB drivers for Windows computers are located on the SAUERMANN USB Thumb Drive:

- When you plug the USB cable from the computer to the monitor, you should hear a small “ding” sound indicating that the USB connection has been made.
- If you have the FTDI USB driver already installed in your computer, the computer will know and will NOT initialize the “New Hardware Wizard”.
- If the New Hardware Wizard appears you need to install the FTDI USB driver. To install this driver:
  1. Locate the FTDI USB driver on the CD and save it to your desktop.
  2. Follow the instructions in the New Hardware Wizard
  3. You will have to go through the wizard **twice**, once to install the ftdiport.inf file and once for the ftdibus.inf file.

### BLUETOOTH® CONNECTION

For Bluetooth® connections, the connection process varies with different Bluetooth® devices. Follow your manufacturer’s instructions for adding a device. The SAUERMANN’ Bluetooth® modem is a Class 1 device, with a maximum range of 100 m. Obstacles such as walls and equipment will reduce the effective range.

1. Turn your instrument on, and it will appear on the screen after a few moments. Select it from the list and click Next.

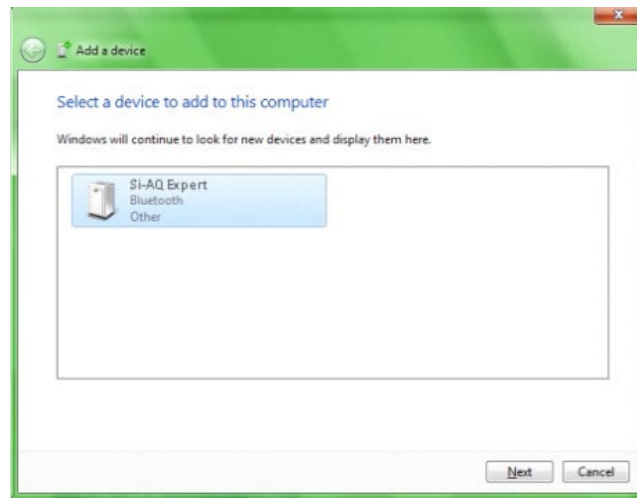

2. On the next screen, select "Enter the device's pairing code" and click Next.

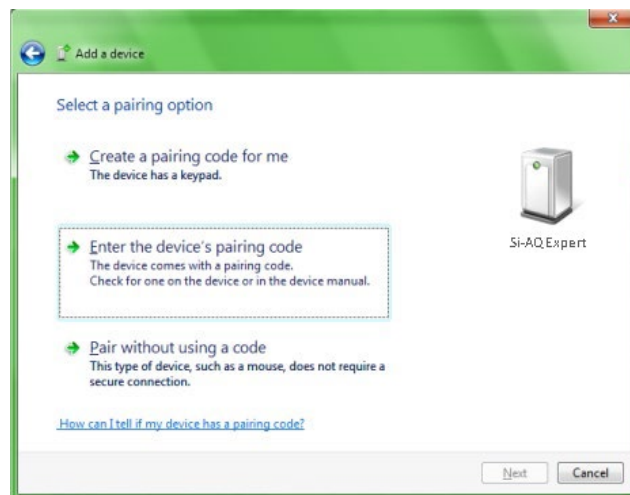

3. Enter the pairing code "1234" or "0000" (four zeros) into the empty field & click Next.



4. Pairing will complete and the PC to instrument communication drivers will be automatically installed.

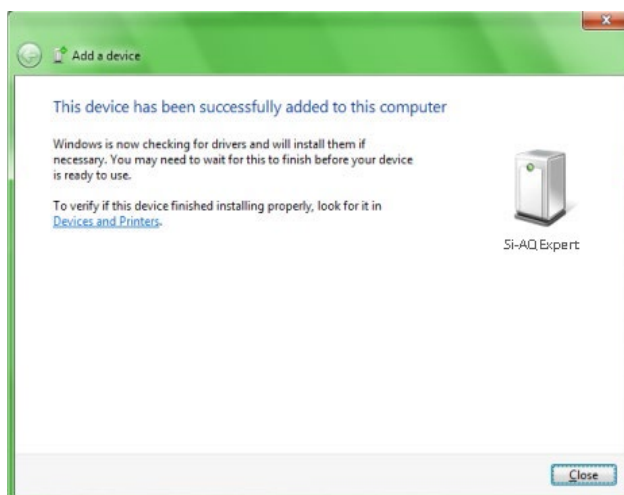

## ALL CONNECTIONS

When you connect your monitor to your computer for the first time, the connection will be assigned a unique *comport* number. Remember the *comport* number as it will be needed to open an SI-AQ PCSOFT session.

You can find the *comport* associated with your SAUERMANN in the Windows Device Manager.

To open the Device Manager:

- Go to the Windows "START" menu, click "RUN" and type **devmgmt.msc** (Or go to the Control Panel, choose the System icon, then the Hardware tab, and click the Device Manager Key).
- A window will open that will list "PORTS" among other items. Click on "PORTS".
- The *comport* will be listed as:
  - USB Serial Port (**USB**)
  - Standard Serial over Bluetooth® link (**Bluetooth®**)

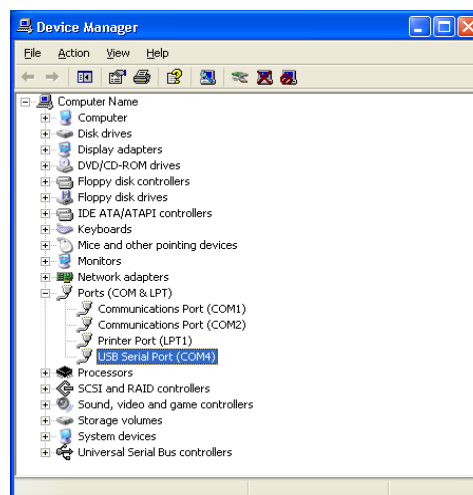

## 2. SI-AQ PCSOFT SOFTWARE

You can enhance the performance and versatility of the SAUERMANN SI-AQ EXPERT by using the SI-AQ PCSOFT software program. SI-AQ PCSOFT is available for most Windows operating systems.

The SI-AQ PCSOFT software is a robust package that allows you to:

1. Monitor all Air Quality parameters.
2. Record maximum, minimum, average for all Air Quality parameters.

	Current	Min	Avg	SD	Max	Units
05/09/13 14:32:35						
T Ambient	78.2	78.1	78.39	0.1	78.5	F
T1	NA		No Cal	No Cal	NA	F
T2	NA		No Cal	No Cal	NA	F
O2	0.1	0.1	0.1	0.	0.1	%
CO	0	0	0.	0.	0	PPM
CO2	552	471	566.77	20.2	598	PPM
NO	0	0	0.	0.	0	PPM
NO2	0	0	0.	0.	0	PPM
NOx	0	0	0.	0.	0	PPM
H2S	0	0	0.	0.	0	PPM
BP	998	998	998.	0.	998	mbar
RH	53.1	52.6	52.9	0.2	53.5	%
DpT	59.7	59.5	59.7	0.1	60.1	F
WBT	66.3	66.2	66.32	0.1	66.6	F
O3	0	0	0.	0.	0	PPB
VOCs	0	0	0.	0.	0	PPB

3. Select a variety of saving and printing options.
4. Retrieve stored data.
5. Set alarms for every air quality parameter including recording the time duration that alarms have been exceeded.
6. Plot bar graphs and time plots of all air quality parameters.

**The SI-AQ PCSOFT software can be downloaded from the included USB Thumb Drive.**

**Windows 8 users may have to load drivers from the following link:**

<http://www.makeuseof.com/tag/how-can-i-install-hardware-with-unsigned-drivers-in-windows-8/>

Consult the SI-AQ PCSOFT manual for details on installing and operating the program. The manual can be accessed by clicking on "Help" and then "How Do I..." in the SI-AQ PCSOFT software program.

### STARTING SI-AQ PCSOFT

- 1 Before starting Si-AQ PCSOFT, have your monitor turned on and connected via USB or Bluetooth®.
- 2 Start SI-AQ PCSOFT. If you have connected before, the monitor icon will appear. If this is the first time you are connecting you will need to add a new port.
- 3 On the SI-AQ PCSOFT window click on "Connections", then click on "Add Port".

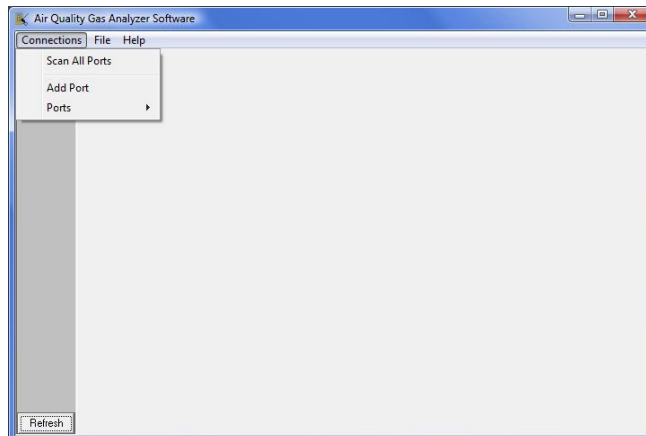

- 4 Enter the COM port number which appeared in the Device Manager and click "OK".
- 5 The COM port with its number should appear on the left side of the SI-AQ PCSOFT window. SI-AQ PCSOFT will look for a monitor on this port. After a moment the SAUERMANN monitor icon should appear. You are now connected to your monitor.
- 6 Click on the SAUERMANN icon. A menu will appear. Choose "Monitor" from the menu. *(Follow the SI-AQ PCSOFT manual for further instructions).*

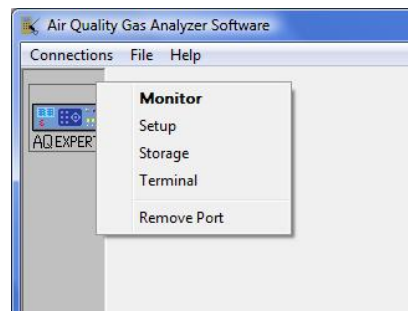



## MAINTENANCE

The Si-AQ Expert Indoor Air Quality Monitor is a sophisticated analytical instrument designed to perform accurate air quality measurements. However, because the monitor is a portable, field/lab used instrument that can be used in many environments, care must be taken to prevent physical and environmental abuse to help maintain trouble-free operation.

There are some of the components that will require periodic inspection or replacement. These are:

1. The disposable fiber line filter for particulates, located inside the of the monitor
2. The disposable round disk condensation filter for moisture, also located inside the of the monitor
3. Gas sensor periodic replacement / Calibration
4. Printer paper replacement (separate optional wireless printer)

<u>INTERVAL</u> *	<u>ITEM</u>	<u>PROCEDURE</u>
Weekly	ZERO Check of ALL Gas Sensors	Zero Gas sensors (See Chapter 9)
Annually	Line & Moisture Filters	Send to Sauermann service center
Annually Every 6 months (if VOC sensor is included)	SPAN Calibration of ALL Gas Sensors	Send to Sauermann service center

*\*Note: These stated intervals are dependent on the unit's usage and applications*

### A. Fiber Line Filter and Condensation Disk Filter Replacement

Send to Sauermann service center

### B. Sensor Replacement

Send to Sauermann service center

### C. Printer Paper Replacement

The external printer uses a high quality 2" thermal paper. Keep any spare paper rolls in a cool dark place to prevent paper discoloration.

- 1) Press the open key on the printer to open the paper cover
- 2) Insert the paper as shown in the image. Remove any remaining core of a used paper roll.
- 3) Make sure to align the paper roll properly.
- 4) Pull the paper out as shown in the image and close the cover.
- 5) Tear off any excess paper in the direction of the side of the printer.

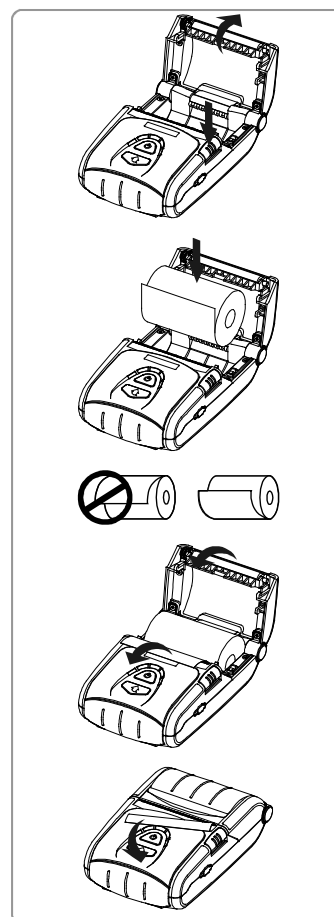

## SI-AQ EXPERT OPTIONS

The SAUERMANN' SI-AQ EXPERT is an extremely versatile Indoor Air Quality (IAQ) measurement system that meets practically all Air Quality measurement requirements. It has been designed as a modular system, permitting the installation, in the field, of most of the various available options. This manual describes the complete instrument equipped with all the options.

The Si-AQ Expert's standard capabilities include Ambient Temperature, Relative Humidity, Wet Bulb, Dew Point, Barometric Pressure, two (2) separate Type K (TCK) thermocouple temperature measurement inputs, Air Velocity measurements, differential pressure measurements, 2000 internal storage tags, Bluetooth® wireless PC communications, REAL-TIME Data Logging capabilities using the included SI-AQ PCSOFT Windows software, USB Cable, and extensive user-friendly help screens. The available additional gas sensor options and accessories are:

### 1. AIR QUALITY MONITOR SENSORS\*

- Carbon Dioxide (CO<sub>2</sub>) – non-dispersive infrared (NDIR) sensor (0-20%)
- Carbon Dioxide (CO<sub>2</sub>) – non-dispersive infrared (NDIR) sensor (0-5000 ppm)
- Carbon Monoxide (CO) – electrochemical sensor (0-200 ppm)
- Oxygen (O<sub>2</sub>) - electrochemical sensor (0-25%)
- Nitrogen Dioxide (NO<sub>2</sub>) - electrochemical sensor (0-20 ppm)
- Nitrogen Oxide (NO) - electrochemical sensor (0-250 ppm)
- Sulfur Dioxide (SO<sub>2</sub>) – electrochemical sensor (0-20 ppm)
- Hydrogen Sulfide (H<sub>2</sub>S) – electrochemical sensor (0-100 ppm)
- Formaldehyde (FMH-CH<sub>2</sub>O) – electrochemical sensor (0-10 ppm)
- Ozone (O<sub>3</sub>) – electrochemical sensor (0-5 ppm)
- Isobutylene (VOC) sensor – Photo ionization detector (PID Sensor) (0-20 ppm)
- Isobutylene (VOC) sensor – Photo ionization detector (PID Sensor) (0-200 ppm)

**\*Note:** When O<sub>3</sub> (Ozone) sensor is installed the Si-AQ Expert can include O<sub>3</sub> + NO<sub>2</sub> **OR** O<sub>3</sub> + SO<sub>2</sub>. The unit can *NOT* have all three (3) sensors (O<sub>3</sub> + NO<sub>2</sub> + SO<sub>2</sub>) together simultaneously.

### 2. OPTIONAL EXTERNAL MEASURING PROBE (Part #: Si-AQ Probe with Hose)

Certain applications might have the need for the optional probe (12" long stainless steel probe with 10' ft long hose) for hard to reach places, separate areas, etc. The probe consists of the stainless steel extraction probe, the sampling line and a Type K thermocouple for external temperature measurements with the probe.



This standard probe (Part # Si-AQ Probe with Hose) is suitable for temperatures up to 800°C/1470°F.

The end of the probe's sampling line connects to the SAMPLE IN quick disconnect connector of the Si-AQ Expert and the thermocouple connector connects to either of the yellow TEMPERATURE 1 or 2 inputs on the Si-AQ Expert.

**3. OPTIONAL VINYL CARRYING CASE  
(Part #: Si-AQ Expert Vinyl Case)**

Dimensions: 15 x 12.6 x 9.8" (38 x 32 x 25 cm)



**4. OPTIONAL PITOT TUBES (Part #: Si-AQ Pitot Tube)**

**Pitot tube** – This optional L-shaped pitot tube consists of stainless steel tubing with the tips open and bent at a certain angle to properly measure air and/or gas velocities. The Pitot tube must always be oriented with the open tips parallel to the direction of the air flow. The end of the Pitot tube assembly is connected by means of two flexible hoses to a very accurate pressure transducer located inside the monitor.



**5. OPTIONAL DIFFERENTIAL PRESSURE HOSES  
(Part #: Si-AQ Diff. Press. Kit)**

This optional PRESSURE HOSES consist of two (2) clear hoses for either (1) single positive pressure connection, one (1) single negative pressure connection, or (2) hoses for differential pressure using both connections simultaneously. The hoses connect to the (-) and/or (+) PRESSURE connections on the Front face of the Si-AQ Expert.



**6. OPTIONAL WIRELESS REMOTE PRINTER  
(Part #: Si-AQ Bluetooth® Printer)**

The Si-AQ Expert uses a wireless Bluetooth® remote printer. The printer is powered by a rechargeable battery. An AC charger is supplied with the printer. The printer is optional with the Si-AQ Expert. See Chapter 8 for more information



**7. OPTIONAL CALIBRATION KIT (ZERO AIR) (Part #: Si-AQ Calibration Kit)**

The Si-AQ Expert uses a bottled Cylinder of ZERO AIR for ZERO Calibration.

Part #: **Si-AQ Calibration Kit** comes with (1) 17L ZERO AIR Cylinder & (1) Regulator

Part #: **Si-AQ Air** is replacement (1) 17L ZERO AIR Cylinder only



## BASIC TROUBLESHOOTING

ZERO ERRORS		
Channel	Possible Causes	Resolution
(Electrochemical sensors) CO NO NO <sub>2</sub> SO <sub>2</sub> H <sub>2</sub> S CH <sub>2</sub> O O <sub>2</sub> O <sub>3</sub>	Sensor has been recently exposed to gas and has not yet returned to zero.	Purge for 10 minutes with fresh air, monitor sensor voltage, and re-zero.
	Insufficient Warm Up	Allow the sensors to warm up after 10 minutes
	Incorrect ZERO calibration	Repeat ZERO calibration in fresh air or with ZERO AIR cylinder
	Pump Failed	Check pump flow, if pump failed replace
	Battery was dead, sensor has destabilized.	Charge battery, wait up to 24 hours for sensors to stabilize, and re-zero.
	Sensor cell life has expired.	Call SAUERMANN for replacement.
(PID sensors) VOC	Sensor has been recently exposed to gas and has not yet returned to zero.	Purge for 10 minutes with fresh air, monitor sensor voltage, and re-zero.
	Battery was discharged, sensor has destabilized.	Charge battery, wait up to 24 hours for sensors to stabilize, and re-zero.
	Sensor cell life has expired.	Call SAUERMANN for replacement.
Temperature Thermocouple	Thermocouple is not connected	Check electrical connections running to the probe
Infrared CO <sub>2</sub>	No response from infrared system	Zero period must be at least 45 seconds. <b>Zero the instrument again with a cylinder ZERO AIR.</b>
	Infrared system is reporting error code	Infrared system may need maintenance.
Velocity	Velocity probe/Pitot Tube is not connected	Check probe and connections.
Bluetooth® connection failure	Connection Failed	Redo connection process
Monitor will not turn on. (Screen is off)	Battery is discharged.	Plug in the charger. Monitor should turn on.
	Battery is not charging.	Check the charger and jack. Check the case for excessive heat.
	Internal initialization problem.	Reset the monitor.
Monitor turns on but screen is blue or faded.	Internal initialization problem.	Reset the monitor.
	Monitor is overheating.	Unplug charger. Check internal fan. Turn on & off to reinitialize.

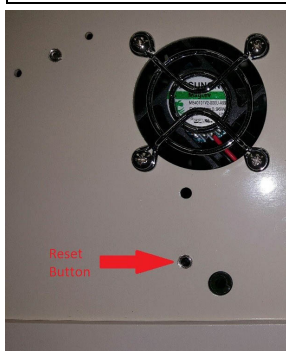

**NOTE:** The reset button is located on the bottom of the analyzer approximately 1.5" (4 cm) from one of the four black feet as shown in the photo below. You will need a pen tip or other small object to press the reset button. Make sure the charger is disconnected from the analyzer when pushing the reset button.

## REPLACEMENT PARTS

<b>PART NUMBER</b>	<b>DESCRIPTION</b>
Si-AQ O2 Cell (0-25%)	O <sub>2</sub> Sensor (0-25%)
Si-AQ CO Cell (0-200 ppm)	CO Sensor (0-200 ppm)
Si-AQ NO Cell (0-250 ppm)	NO Sensor (0-250 ppm)
Si-AQ NO2 Cell (0-20 ppm)	NO <sub>2</sub> Sensor (0-20 ppm)
Si-AQ SO2 Cell (0-20 ppm)	SO <sub>2</sub> Sensor (0-20 ppm)
Si-AQ H2S Cell (0-100 ppm)	H <sub>2</sub> S Sensor (0-100 ppm)
Si-AQ O3 Cell (0-5 ppm)	O <sub>3</sub> Sensor (0-5 ppm)
Si-AQ CO2 Sensor (0-5000 ppm)	NDIR CO <sub>2</sub> Sensor (0-5000 ppm)
Si-AQ CO2 Cell (0-20%)	NDIR CO <sub>2</sub> Sensor (0-20%)
Si-AQ VOC Cell (0-20k ppb)	PID VOC Sensor (0-20 ppm)
Si-AQ VOC Cell (0-200 ppm)	PID VOC Sensor (0-200 ppm)
Si-AQ CH2O Cell (0-10 ppm)	Formaldehyde Sensor (0-10 ppm)
Si-AQ Calibration Kit	Calibration KIT – ZERO AIR Cylinder w/ Regulator
Si-AQ Air	Replacement ZERO AIR Cylinder ONLY
Si-AQ Expert Vinyl Case	Vinyl Carrying Case with Shoulder Strap
Si-AQ Bluetooth® Printer	Remote Bluetooth® Wireless Printer
Si-AQ Probe with Hose	12" Probe and 10' hose
Si-AQ Diff. Press. Kit	Differential Pressure Hoses
Si-AQ VOC Zero Filter	Disposable ZERO Filter (VOCs)

---

VOCs Ionization Potentials and Response Factors
*Appendix I: Ionization Potentials***Chemical Name IP (electron volts)****A**

2-Amino pyridine 8  
 Acetaldehyde 10.21  
 Acetamide 9.77  
 Acetic acid 10.69  
 Acetic anhydride 10  
 Acetone 9.69  
 Acetonitrile 12.2  
 Acetophenone 9.27  
 Acetyl bromide 10.55  
 Acetyl chloride 11.02  
 Acetylene 11.41  
 Acrolein 10.1  
 Acrylamide 9.5  
 Acrylonitrile 10.91  
 Allyl alcohol 9.67  
 Allyl chloride 9.9  
 \*Ammonia 10.2  
 Aniline 7.7  
 Anisidine 7.44  
 Anisole 8.22  
 Arsine 9.89

**B**

1,3-Butadiene (butadiene) 9.07  
 1-Bromo-2-chloroethane 10.63  
 1-Bromo-2-methylpropane 10.09  
 1-Bromo-4-fluorobenzene 8.99  
 1-Bromobutane 10.13  
 1-Bromopentane 10.1  
 1-Bromopropane 10.18  
 1-Bromopropene 9.3  
 1-Butanethiol 9.14  
 1-Butene 9.58  
 1-Butyne 10.18  
 2,3-Butadione 9.23  
 2-Bromo-2-methylpropane 9.89  
 2-Bromobutane 9.98  
 2-Bromopropane 10.08  
 2-Bromothiophene 8.63  
 2-Butanone (MEK) 9.54  
 3-Bromopropene 9.7  
 3-Butene nitrile 10.39  
 Benzaldehyde 9.53  
 Benzene 9.25  
 Benzenethiol 8.33  
 Benzotrifluoride 9.71  
 Benzotrifluoride 9.68  
 Biphenyl 8.27  
 Boron oxide 13.5

Boron trifluoride 15.56  
 Bromine 10.54  
 Bromobenzene 8.98  
 Bromochloromethane 10.77  
 Bromoform 10.48  
 Butane 10.63  
 Butyl mercaptan 9.15  
 cis-2-Butene 9.13  
 m-Bromotoluene 8.81  
 n-Butyl acetate 10.01  
 n-Butyl alcohol 10.04  
 n-Butyl amine 8.71  
 n-Butyl benzene 8.69  
 n-Butyl formate 10.5  
 n-Butyraldehyde 9.86  
 n-Butyric acid 10.16  
 n-Butyronitrile 11.67  
 o-Bromotoluene 8.79  
 p-Bromotoluene 8.67  
 p-tert-Butyltoluene 8.28  
 s-Butyl amine 8.7  
 s-Butyl benzene 8.68  
 sec-Butyl acetate 9.91  
 t-Butyl amine 8.64  
 t-Butyl benzene 8.68  
 trans-2-Butene 9.13

**C**

1-Chloro-2-methylpropane 10.66  
 1-Chloro-3-fluorobenzene 9.21  
 1-Chlorobutane 10.67  
 1-Chloropropane 10.82  
 2-Chloro-2-methylpropane 10.61  
 2-Chlorobutane 10.65  
 2-Chloropropane 10.78  
 2-Chlorothiophene 8.68  
 3-Chloropropene 10.04  
 Camphor 8.76  
 Carbon dioxide 13.79  
 Carbon disulfide 10.07  
 Carbon monoxide 14.01  
 Carbon tetrachloride 11.47  
 Chlorine 11.48  
 Chlorine dioxide 10.36  
 Chlorine trifluoride 12.65  
 Chloroacetaldehyde 10.61  
 a -Chloroacetophenone 9.44  
 Chlorobenzene 9.07  
 Chlorobromomethane 10.77  
 Chlorofluoromethane (Freon 22) 12.45  
 Chloroform 11.37  
 Chlorotrifluoromethane (Freon 13) 12.91  
 Chrysene 7.59

Cresol 8.14  
Crotonaldehyde 9.73  
Cumene (isopropyl benzene) 8.75  
Cyanogen 13.8  
Cyclohexane 9.8  
Cyclohexanol 9.75  
Cyclohexanone 9.14  
Cyclohexene 8.95  
Cyclo-octatetraene 7.99  
Cyclopentadiene 8.56  
Cyclopentane 10.53  
Cyclopentanone 9.26  
Cyclopentene 9.01  
Cyclopropane 10.06  
m-Chlorotoluene 8.83  
o-Chlorotoluene 8.83  
p-Chlorotoluene 8.7

## D

1,1-Dibromoethane 10.19  
1,1-Dichloroethane 11.12  
1,1-Dimethoxyethane 9.65  
1,1-Dimethylhydrazine 7.28  
1,2-Dibromoethene 9.45  
1,2-Dichloro-1,1,2,2-tetrafluoroethane (Freon 114) 12.2  
1,2-Dichloroethane 11.12  
1,2-Dichloropropane 10.87  
1,3-Dibromopropane 10.07  
1,3-Dichloropropane 10.85  
2,2-Dimethyl butane 10.06  
2,2-Dimethyl propane 10.35  
2,3-Dichloropropene 9.82  
2,3-Dimethyl butane 10.02  
3,3-Dimethyl butanone 9.17  
cis-Dichloroethene 9.65  
Decaborane 9.88  
Diazomethane 9  
Diborane 12  
Dibromochloromethane 10.59  
Dibromodifluoromethane 11.07  
Dibromomethane 10.49  
Dibutylamine 7.69  
Dichlorodifluoromethane (Freon 12) 12.31  
Dichlorofluoromethane 12.39  
Dichloromethane 11.35  
Diethoxymethane 9.7  
Diethyl amine 8.01  
Diethyl ether 9.53  
Diethyl ketone 9.32  
Diethyl sulfide 8.43  
Diethyl sulfite 9.68  
Difluorodibromomethane 11.07  
Dihydropyran 8.34  
Diiodomethane 9.34  
Diisopropylamine 7.73  
Dimethoxymethane (methylal) 10  
Dimethyl amine 8.24  
Dimethyl ether 10  
Dimethyl sulfide 8.69  
Dimethylaniline 7.13

Dimethylformamide 9.18  
Dimethylphthalate 9.64  
Dinitrobenzene 10.71  
Dioxane 9.19  
Diphenyl 7.95  
Dipropyl amine 7.84  
Dipropyl sulfide 8.3  
Durene 8.03  
m-Dichlorobenzene 9.12  
N,N-Diethyl acetamide 8.6  
N,N-Diethyl formamide 8.89  
N,N-Dimethyl acetamide 8.81  
N,N-Dimethyl formamide 9.12  
o-Dichlorobenzene 9.06  
p-Dichlorobenzene 8.95  
p-Dioxane 9.13  
trans-Dichloroethene 9.66

## E

Epichlorohydrin 10.2  
Ethane 11.65  
Ethanethiol (ethyl mercaptan) 9.29  
Ethanamine 8.96  
Ethene 10.52  
Ethyl acetate 10.11  
Ethyl alcohol 10.48  
Ethyl amine 8.86  
Ethyl benzene 8.76  
Ethyl bromide 10.29  
Ethyl chloride (chloroethane) 10.98  
Ethyl disulfide 8.27  
Ethylene 10.5  
Ethyl ether 9.51  
Ethyl formate 10.61  
Ethyl iodide 9.33  
Ethyl isothiocyanate 9.14  
Ethyl mercaptan 9.29  
Ethyl methyl sulfide 8.55  
Ethyl nitrate 11.22  
Ethyl propionate 10  
Ethyl thiocyanate 9.89  
Ethylene chlorohydrin 10.52  
Ethylene diamine 8.6  
Ethylene dibromide 10.37  
Ethylene dichloride 11.05  
Ethylene oxide 10.57  
Ethyleneimine 9.2  
Ethynylbenzene 8.82

## F

2-Furaldehyde 9.21  
Fluorine 15.7  
Fluorobenzene 9.2  
Formaldehyde 10.87  
Formamide 10.25  
Formic acid 11.05  
Freon 11 (trichlorofluoromethane) 11.77  
Freon 112 (1,1,2,2-tetrachloro-1,2-difluoroethane) 11.3  
Freon 113 (1,1,2-trichloro-1,2,2-trifluoroethane) 11.78  
Freon 114 (1,2-dichloro-1,1,2,2-tetrafluoroethane) 12.2

Freon 12 (dichlorodifluoromethane) 12.31  
Freon 13 (chlorotrifluoromethane) 12.91  
Freon 22 (chlorofluoromethane) 12.45  
Furan 8.89  
Furfural 9.21  
m-Fluorotoluene 8.92  
o-Fluorophenol 8.66  
o-Fluorotoluene 8.92  
p-Fluorotoluene 8.79

## H

1-Hexene 9.46  
2-Heptanone 9.33  
2-Hexanone 9.35  
Heptane 10.08  
Hexachloroethane 11.1  
Hexane 10.18  
Hydrazine 8.1  
Hydrogen 15.43  
Hydrogen bromide 11.62  
Hydrogen chloride 12.74  
Hydrogen cyanide 13.91  
Hydrogen fluoride 15.77  
Hydrogen iodide 10.38  
Hydrogen selenide 9.88  
Hydrogen sulfide 10.46  
Hydrogen telluride 9.14  
Hydroquinone 7.95

## I

1-Iodo-2-methylpropane 9.18  
1-Iodobutane 9.21  
1-Iodopentane 9.19  
1-Iodopropane 9.26  
2-Iodobutane 9.09  
2-Iodopropane 9.17  
Iodine 9.28  
Iodobenzene 8.73  
Isobutane (Isobutylene) 9.4  
Isobutyl acetate 9.97  
Isobutyl alcohol 10.12  
Isobutyl amine 8.7  
Isobutyl formate 10.46  
Isobutyraldehyde 9.74  
Isobutyric acid 10.02  
Isopentane 10.32  
Isophorone 9.07  
Isoprene 8.85  
Isopropyl acetate 9.99  
Isopropyl alcohol 10.16  
Isopropyl amine 8.72  
Isopropyl benzene 8.69  
Isopropyl ether 9.2  
Isovaleraldehyde 9.71  
m-Iodotoluene 8.61  
o-Iodotoluene 8.62  
p-Iodotoluene 8.5

## K

Ketene 9.61

## L

2,3-Lutidine 8.85  
2,4-Lutidine 8.85  
2,6-Lutidine 8.85

## M

2-Methyl furan 8.39  
2-Methyl naphthalene 7.96  
1-Methyl naphthalene 7.96  
2-Methyl propene 9.23  
2-Methyl-1-butene 9.12  
2-Methylpentane 10.12  
3-Methyl-1-butene 9.51  
3-Methyl-2-butene 8.67  
3-Methylpentane 10.08  
4-Methylcyclohexene 8.91  
Maleic anhydride 10.8  
Mesityl oxide 9.08  
Mesitylene 8.4  
Methane 12.98  
Methanethiol (methyl mercaptan) 9.44  
Methyl acetate 10.27  
Methyl acetylene 10.37  
Methyl acrylate 9.9  
Methyl alcohol 10.85  
Methyl amine 8.97  
Methyl bromide 10.54  
Methyl butyl ketone 9.34  
Methyl butyrate 10.07  
Methyl cellosolve 9.6  
Methyl chloride 11.28  
Methyl chloroform (1,1,1-trichloroethane) 11  
Methyl disulfide 8.46  
Methyl ethyl ketone 9.53  
Methyl formate 10.82  
Methyl iodide 9.54  
Methyl isobutyl ketone 9.3  
Methyl isobutyrate 9.98  
Methyl isocyanate 10.67  
Methyl isopropyl ketone 9.32  
Methyl isothiocyanate 9.25  
Methyl mercaptan 9.44  
Methyl methacrylate 9.7  
Methyl propionate 10.15  
Methyl propyl ketone 9.39  
a -Methyl styrene 8.35  
Methyl thiocyanate 10.07  
Methylal (dimethoxymethane) 10  
Methylcyclohexane 9.85  
Methylene chloride 11.32  
Methyl-n-amyl ketone 9.3  
Monomethyl aniline 7.32  
Monomethyl hydrazine 7.67  
Morpholine 8.2  
n-Methyl acetamide 8.9

## N



1-Nitropropane 10.88  
2-Nitropropane 10.71  
Naphthalene 8.12  
Nickel carbonyl 8.27  
Nitric oxide, (NO) 9.25  
Nitrobenzene 9.92  
Nitroethane 10.88  
Nitrogen 15.58  
Nitrogen dioxide 9.78  
Nitrogen trifluoride 12.97  
Nitromethane 11.08  
Nitrotoluene 9.45  
p-Nitrochloro benzene 9.96

## O

Octane 9.82  
Oxygen 12.08  
Ozone 12.08

## P

1-Pentene 9.5  
1-Propanethiol 9.2  
2,4-Pentanedione 8.87  
2-Pentanone 9.38  
2-Picoline 9.02  
3-Picoline 9.02  
4-Picoline 9.04  
n-Propyl nitrate 11.07  
Pentaborane 10.4  
Pentane 10.35  
Perchloroethylene 9.32  
Pheneloc 8.18  
Phenol 8.5  
Phenyl ether (diphenyl oxide) 8.82  
Phenyl hydrazine 7.64  
Phenyl isocyanate 8.77  
Phenyl isothiocyanate 8.52  
Phenylene diamine 6.89  
Phosgene 11.77  
Phosphine 9.87  
Phosphorus trichloride 9.91  
Phthalic anhydride 10  
Propane 11.07  
Propargyl alcohol 10.51  
Propiolactone 9.7  
Propionaldehyde 9.98  
Propionic acid 10.24  
Propionitrile 11.84  
Propyl acetate 10.04  
Propyl alcohol 10.2  
Propyl amine 8.78  
Propyl benzene 8.72  
Propyl ether 9.27  
Propyl formate 10.54  
Propylene 9.73  
Propylene dichloride 10.87  
Propylene imine 9  
Propylene oxide 10.22  
Propyne 10.36

## *Appendix II: Response Factors*

Pyridine 9.32  
Pyrrole 8.2

## Q

Quinone 10.04

## S

Stibine 9.51  
Styrene 8.47  
Sulfur dioxide 12.3  
Sulfur hexafluoride 15.33  
Sulfur monochloride 9.66  
Sulfuryl fluoride 13

## T

o-Terphenyls 7.78  
1,1,2,2-Tetrachloro-1,2-difluoroethane (Freon 112) 11.3  
1,1,1-Trichloroethane 11  
1,1,2-Trichloro-1,2,2-trifluoroethane (Freon 113) 11.78  
2,2,4-Trimethyl pentane 9.86  
o-Toluidine 7.44  
Tetrachloroethane 11.62  
Tetrachloroethene 9.32  
Tetrachloromethane 11.47  
Tetrahydrofuran 9.54  
Tetrahydropyran 9.25  
Thiolacetic acid 10  
Thiophene 8.86  
Toluene 8.82  
Tribromoethene 9.27  
Tribromofluoromethane 10.67  
Tribromomethane 10.51  
Trichloroethene 9.45  
Trichloroethylene 9.47  
Trichlorofluoromethane (Freon 11) 11.77  
Trichloromethane 11.42  
Triethylamine 7.5  
Trifluoromonobromo-methane 11.4  
Trimethyl amine 7.82  
Tripropyl amine 7.23

## V

o-Vinyl toluene 8.2  
Valeraldehyde 9.82  
Valeric acid 10.12  
Vinyl acetate 9.19  
Vinyl bromide 9.8  
Vinyl chloride 10  
Vinyl methyl ether 8.93

## W

Water 12.59

## X

2,4-Xylidine 7.65  
m-Xylene 8.56  
o-Xylene 8.56  
p-Xylene 8.45

1,2,3-trimethylbenzene 0.49  
1,2,4-trimethylbenzene 0.43  
1,2-dibromoethane 11.7  
1,2-dichlorobenzene 0.5  
1,2-dichloroethane (11.7 lamp) 0.5  
1,3,5-trimethylbenzene 0.34  
1,4-dioxane 1.4  
1-butanol 3.4  
1-methoxy-2-propanol 1.4  
1-propanol 5.7  
2-butoxyethanol 1.3  
2-methoxyethanol 2.5  
2-pentanone 0.78  
2-picoline 0.57  
3-picoline 0.9  
4-hydroxy-4-methyl-2-pentanone 0.55  
4-methylbenzyl alcohol 0.8  
acetaldehyde 10.8  
acetic acid 11  
acetone 1.2  
acetophenone 0.59  
acrolein 3.9  
allyl alcohol 2.5  
ammonia 9.4  
amylacetate 3.5  
arsine 2.6  
benzene 0.53  
bromoform 2.3  
bromomethane 1.8  
butadiene 0.69  
butyl acetate 2.4  
carbon disulfide 1.2  
chlorobenzene 0.4  
cumene (isopropylbenzene) 0.54  
cyclohexane 1.5  
cyclohexanone 0.82  
decane 1.6  
diethylamine 1  
dimethoxymethane 11.3  
dimethyl disulfide 0.3  
diesel fuel #1 0.9  
diesel fuel #2 0.75  
epichlorhydrin 7.6  
ethanol 10  
ethyl acetate 4.2  
ethyl acetoacetate 0.9  
ethyl acrylate 2.3  
ethyl ether (diethyl ether) 1.2  
ethyl mercaptan 0.6  
ethylbenzene 0.51  
ethylene 10.1  
ethylene glycol 15.7  
ethylene oxide 19.5  
gasoline 1.1  
heptane 2.5  
hydrazine 2.6  
hydrogen sulfide 3.2  
isoamyl acetate 1.8  
isobutanol 4.7  
isobutyl acetate 2.6  
isobutylene 1  
isooctane 1.3  
isopentane 8  
isophorone 0.74  
isoprene (2-methyl-1,3-butadiene) 0.6  
isopropanol 5.6  
isopropyl acetate 2.6  
isopropyl ether 0.8  
isopropylamine 0.9  
Jet A fuel 0.4  
JP-5 fuel 0.48  
JP-8 fuel 0.48  
mesityl oxide 0.47  
methanol (11.7 lamp) 2.5  
methyl acetate 7  
methyl acetoacetate 1.1  
methyl acrylate 3.4  
methyl benzoate 0.93  
methyl ethyl ketone 0.9  
methyl isobutyl ketone 1.1  
methyl mercaptan 0.6  
methyl methacrylate 1.5  
methyl tert-butyl ether 0.86  
methylamine 1.2  
methylene chloride (11.7 lamp) 0.85  
m-xylene 0.53  
naphtalene 0.37  
n,n-dimethylacetamide 0.73  
n,n-dimethylformamide 0.8  
n-hexane 4.5  
nitric oxide 7.2  
n-nonane 1.6  
nitrogen dioxide (11.7 lamp) 10  
n-pentane 9.7  
n-propyl acetate 3.1  
octane 2.2  
o-xylene 0.54  
phenol 1  
phosphine 2.8  
pinene, alpha 0.4  
pinene, beta 0.4  
propionaldehyde (propanal) 14.8  
propylene 1.3  
propylene oxide 6.5  
p-xylene 0.5  
pyridine 0.79  
quinoline 0.72  
styrene 0.4  
tert-butyl alcohol 3.4  
tert-butyl mercaptan 0.55  
tert-butylamine 0.71  
tetrachloroethylene 0.56  
tetrahydrofuran 1.6  
thiophene 0.47  
toluene 0.53  
trans-1,2-Dichloroethene 0.45  
trichloroethylene 0.5  
trimethylamine 0.83  
turpentine - crude sulfite 1  
turpentine - pure gum 0.45

vinyl acetate 1.3  
vinyl bromide 0.4  
vinyl chloride 1.8

vinylcyclohexane (VCH) 0.54  
vinylidene chloride (1,1-DC



**BE CAREFUL! Material damages can happen, so please apply the precautionary measures indicated.**



Once returned, required waste collection will be assured in the respect of the environment in accordance to guidelines relating to WEEE.