



DATA SHEET



TST



Thermostats



Range from 0 to 50°C ⁽¹⁾,
from -20 to +80°C ⁽²⁾ and
from -100 to 400°C ⁽³⁾



Visual and audible alarm,
red led in front

Features

- RCR relay output 3A/240 Vac (NC), power supply 24 Vac/Vdc
- “1/4 turn” system mounting with wall-mount plate
- ABS V0 IP65 housing (remote model) or IP20 (ambient model)
- Housing with simplified mounting system

Measured parameters

Parameter	Accuracy ⁽⁴⁾	Measuring range	Resolution
Temperature	Pt100: ±0.5% of reading ±0.5°C NTC: ±0.3°C (from -40°C to 70°C); ±0.5°C outside	Ambient model: from 0 to 50°C Duct model: from -20 to +80°C Model with terminal block: from -100 to +400°C	0.1°C

Part number

TST - [] - []

Type of housing:
B: terminal block
A: duct
S: ambient

Type of probe:
I: stainless steel probe (only for duct models)

Example: TST-AI
Thermostat with stainless steel duct probe

Technical specifications

Output	1 RCR relay 3 A / 230 Vac. NO (normally opened); 5A / NC (normally closed); 3A / 240 Vac. Common mode voltage <30 Vac.
Power supply	24 Vac/Vdc ±10%
Consumption	3 VA
Relay and alarm status	Red led in front and internal buzzer (70 dB at 10 cm)
European directives	2014/30/EU EMC; 2014/35/EU Low Voltage; 2011/65/EU RoHS II; 2012/19/EU WEEE
Electrical connection	Terminal block for cables Ø0.05 to 2.5 mm ² . Carried out according to the code of good practice
PC communication	USB-mini Din cable
Environment	Air and neutral gases

⁽¹⁾ Ambient model / ⁽²⁾ Duct model / ⁽³⁾ Pt100 terminal block model

⁽⁴⁾ All the accuracies indicated in this technical datasheet were stated in laboratory conditions, and can be guaranteed for measurements carried out in the same conditions, or carried out with calibration compensation.

General features

Units of measurement	°C, °F
Response time	1/e (63%) 5 sec. (ambient) 1/e (63%) 20 sec. (airtight)
Type of sensor	Pt100 (model with terminal block and stainless steel duct model) NTC (ambient model and duct model)
Type of fluid	Air and neutral gas
Conditions of use (°C/%RH/m)	From 0 to +50°C. In non-condensing condition. From 0 to 2000 m.
Storage temperature	From -10 to +70°C

Features of the housing

Material	ABS V0 as per UL94
Protection	Duct model and model with terminal block: IP65 Ambient model: IP20
Display	LCD 10 digits. Size: 50 x 17 mm Height of digits: Values: 10 mm; Units: 5 mm
Weight	162 g
Cable gland (duct and terminal block models)	For cables of Ø8 mm maximum
Cable of remote probe	2 m length, Ø4.8 mm in PVC

Dimensions

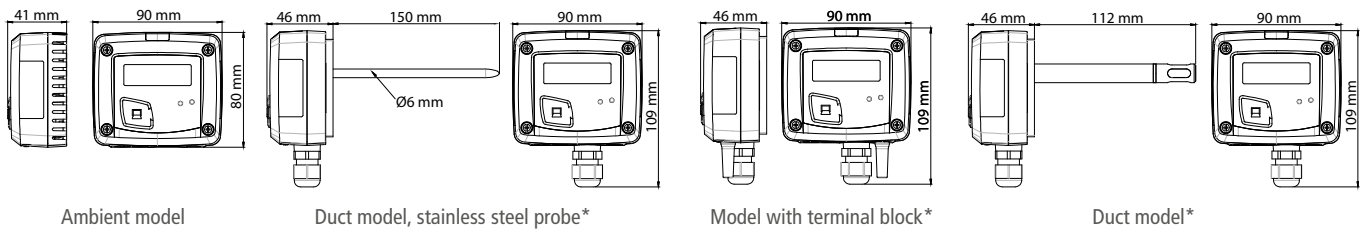

Connections



Connection of a Pt100 probe on terminal block:

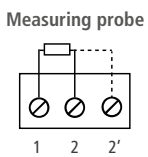

- | | |
|---|--------------------------------|
| 1. Switch | 5. Button for settings |
| 2. Terminal block (only on model with terminal block) | 6. Relay terminal block |
| 3. LCC-S software connection | 7. Power supply terminal block |
| 4. Alarm led | 8. Cable gland |

Electrical connections as per NFC15-100 standard



This connection must be made by a qualified and trained technician. To make the connection, the transmitter must not be energized.

NO: normally opened
COM: common
NC: normally closed

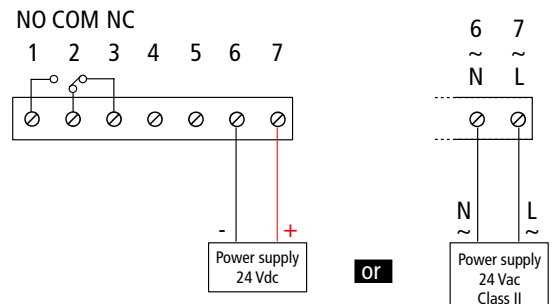

Settings and use of the transmitter

Configuration



To configure the transmitter, it must not be energized. Then, you can make the settings required, with the DIP switches (as shown on the drawing below). When the transmitter is configured, you can power it up.

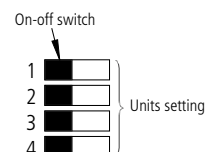

*Different probes available as option.

- Units setting**

To set a unit of measurement, put the on-off switch 4 of the units as shown beside.

Configurations	° C	° F
Combinations	1 <input type="checkbox"/>	1 <input type="checkbox"/>
	2 <input type="checkbox"/>	2 <input type="checkbox"/>
	3 <input type="checkbox"/>	3 <input type="checkbox"/>
	4 <input type="checkbox"/>	4 <input type="checkbox"/>

- Thresholds configuration**

The button  allows to activate or not an alarm (threshold), to set the action of the alarm (edge), to set the threshold(s) value, to set the time-delay and to acknowledge the alarm.

Working principle:

- By pressing on the button more than 3 seconds, you can validate the setting and go to the next setting.
- By pressing quickly on the button, you can increment a value and scroll down the different option or values.

- Activate or deactivate an alarm**

- Press on the button for 3 seconds, "CONF" is displayed then "NEG", meaning that the relay is in negative security, it is excited during an alarm condition.
- If needed, press quickly on the button to switch the relay in positive security, the relay is de-energized during an alarm condition or a current breaking, "POS" is displayed.
- Press 3 s on the button, "Buzz" screen is displayed with "ON" or "OFF" blinking. Briefly press on the button to activate ("ON") or deactivate ("OFF") (according to the last saved configuration) the buzzer during an alarm condition.
- Press 3 s on the button, "Alarm" screen is displayed with "On" or "Off" blinking (according to the last saved configuration).
- Press quickly on the button, the display changes from "On" (activated alarm) to "Off" (deactivated alarm).
- Press 3 seconds on the button to confirm the setting. If the alarm is deactivated, the instrument displays the measurement; if the alarm is activated, the instrument displays the following setting.

- Set the action of the alarm (rising edge or falling edge)**

The edge determines the action of the alarm according to the trespassing direction of the threshold(s).

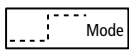

Rising edge (1 threshold): the alarm goes off when the measurement exceeds the threshold and stops when it is below the threshold.

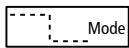

Falling edge (1 threshold): the alarm goes off when the measurement is below the threshold and stops when it exceeds the threshold.



Monitoring (2 thresholds): the alarm goes off when the measurement is outside the defined low and high thresholds.

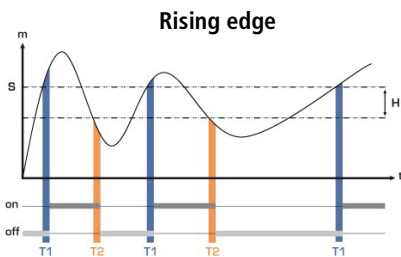

Measurement (m) > Threshold (S) during the time-delay T1: Alarm activation.
Measurement (m) < Threshold (S) - Hysteresis (H) during the time-delay T2: Alarm deactivation.

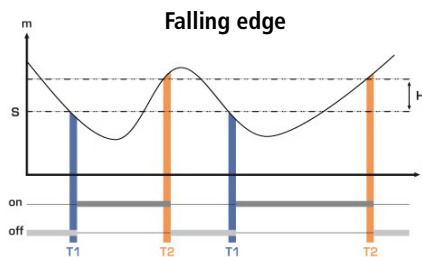

Measurement (m) < Threshold (S) during the time-delay T1: Alarm activation.
Measurement (m) > Threshold (S) + Hysteresis (H) during time-delay T2: Alarm deactivation.

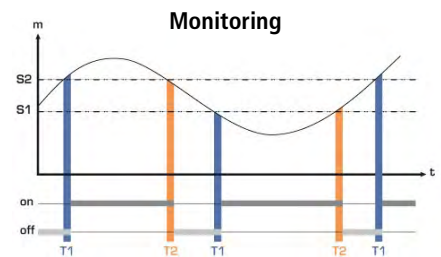

The alarm goes off when the measurement is outside the low and high thresholds.

- Press briefly on the button to select the trespassing direction then press the button more than 3 seconds to validate this direction and set the thresholds.

- Set the threshold(s) value**

The first digit blinks, it corresponds to the positive (0) or negative (-) setting of the threshold value. Press briefly on the button to select the sign for the threshold value. Press on the button more than 3 seconds to validate.

The second digit blinks, press briefly on the button to scroll the numbers. Press the button more than 3 seconds to validate.

Repeat the process until the last digit to configure the threshold value, validate the threshold and go to the following setting.

If the monitoring edge has been selected, the transmitter displays the setting of the second threshold.

- Set the hysteresis**

The hysteresis is only for the rising edge and the falling edge modes.

In rising edge mode, the hysteresis allows to the transmitter to stay in alarm when the measurement is between the threshold and the threshold minus the hysteresis.

Ex: for a 70°C threshold and a 10°C hysteresis, the instrument will stay in alarm when the measurement will be between 70 and 60°C. In falling edge mode, the hysteresis allows to the transmitter to stay in alarm when the measurement is between the threshold and the threshold plus the hysteresis.

Ex: for a 70°C threshold and a 10°C hysteresis, the instrument will stay in alarm when the measurement will be between 70 and 80°C. The first digit blinks, set it pressing the button briefly several times then press on the button more than 3 seconds to set the following digit..

Once the hysteresis is set, press the button more than 3 seconds to validate and set the time-delays.

- **Set the time-delay 1 and the time-delay 2 (600 seconds maximum)**

- In rising edge mode, the time-delay 1 corresponds to the time lag before the alarm goes off when the threshold has been reached. The time-delay 2, corresponds to the time lag before the alarm stops when the measurement is lower than the threshold minus the hysteresis.

Setting procedure: "Time 1" for the time-delay 1 is displayed then the time in second. The first digit blinks, press briefly on the button and scroll the figures. Press on the button more than 3 seconds to validate. Repeat the process until the last digit to set the time-delay 1 value (from 0 to 600 s) and validate. **"Time 2"** is displayed the time in second. Repeat the process to set the time-delay 2.

- In falling edge mode, the time-delay 1 corresponds to the time lag before the alarm goes off when the threshold has been reached. The time-delay 2, corresponds to the time lag before the alarm stops when the measurement is lower than the threshold plus the hysteresis.

The setting procedure is the same as the rising edge procedure.

- In monitoring mode, the alarm of the transmitter goes off when the measurement is below the lower threshold and higher the high threshold. The time-delay 1 corresponds to the time lag before the alarm goes off when the measurement is below the lower threshold and higher the high threshold. The time-delay 2 corresponds to the time lag before the alarm stops when the measurement is between the lower and higher thresholds.

The setting procedure is the same as the rising edge procedure.

The setting of time delays is done, the measurement is displayed.

Configuration via LCC-S software (optional)

The software allows to set the alarms, the thresholds, and the time-delay of the transmitter.

- To access the configuration via software:
 - Set the DIP switches as shown beside.
 - Connect the cable of the LCC-S to the connection of the transmitter. Please refer to the user manual of the LCC-S software to make the configuration.

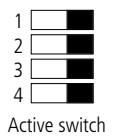

The configuration of the parameters can be done either with the DIP switch or via software (you can not combine both solutions). Switch off the sensor before settings process.

Mounting

To mount the transmitter, mount the ABS plate on the wall (drilling: Ø6 mm, screws and pins are supplied). Insert the transmitter on the fixing plate (see A on the drawing beside). Rotate the housing in clockwise direction until you hear a "click" which confirms that the transmitter is correctly installed.



Ambient model has not any fixing plate. 4 fixing holes are inside the back housing. Use them to install the transmitter on the required location.

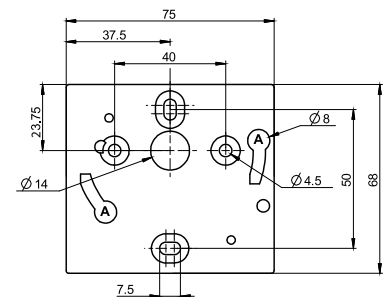

Maintenance

Please avoid any aggressive solvent. Please protect the transmitter and its probes from any cleaning product containing formalin, that may be used for cleaning rooms or ducts.

Precautions for use

Please always use the device in accordance with its intended use and within parameters described in the technical features in order not to compromise the protection ensured by the device.

Accessories

Name	Reference
Power supply class 2, 230 Vac input, 24 Vac output	KIAL-100A
Configuration software with USB cable	LCC-S
Stainless steel Pt100 2 or 3 wires probes or NTC probes for duct models and remote models available on request	-



Only the accessories supplied with the device must be used.

